

OPERATION MANUAL

X-BLUE

ALKALINE WATER IONIZER



Warning: Incorrect installation and/or operation could void your valuable warranty.
Please protect your investment! READ THIS MANUAL CAREFULLY



TABLE OF CONTENTS

Description

Safety Precautions

Power Related	03
Installation Precautions	04-05
During Usage	06
pH Reagent Liquid Precautions	07
Some helpful tips	07

How to Use

Names and functions of Parts I	08-09
Names and functions of Parts II	10-11
How to install	12-13
How to Use	14-17
What is alkaline electrolyzed-reduced water?	18-19
How to Measure pH	20
How to replace the filter	21-23
Filter Composition	24
Water Flow Diagram	25

Customer Service

Trouble shooting guide	26-27
Specifications	28
Warranty Card	29

Safety Precautions

If a break down occurs, do not make a repair by yourself. Contact the place of purchase or A/S center.



Electrical power precautions



If your ionizer becomes submerged in water, unplug the power cord from the wall BEFORE removing the ionizer from the water. Failure to do so may cause electric shock!



NEVER attempt to repair or service the unit yourself. Contact your dealer. Attempting to do so will void your valuable warranty!

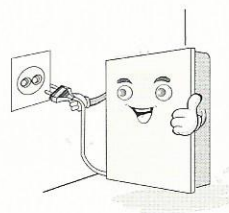

Do not use your ionizer at voltages other than specified (AC 230V FOR Europe). Use a GFI outlet. Do not plug in your ionizer where it will exceed the rating of outlet or electric wiring. Failure to do so can result in fire, injury and/or damage to yourself, wiring or ionizer!

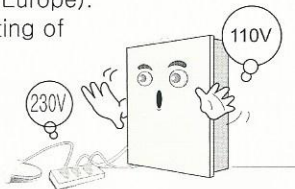

NEVER touch the power cord or plug with wet hands – this may result in electric shock!

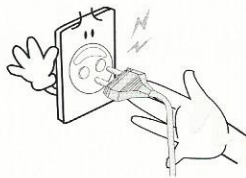

Safety Precautions



Ensure the power plug is firmly and properly inserted into the outlet
– failure to do so may result in electric shock or fire!



Do not wash your ionizer by immersion or by pouring water over the main body;
always unplug your ionizer while cleaning the casing.
Clean with damp sponge or cloth.



Installation Precautions



Protect your ionizer from freezing temperatures.

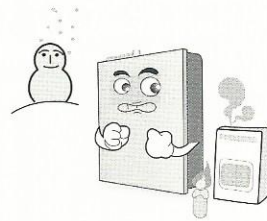

Protect your ionizer from direct sunlight.

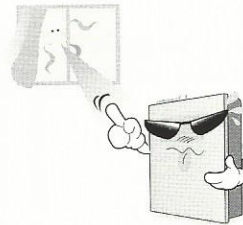



Do not put anything heavy on top of your ionizer.
Do not install your ionizer on an unstable or soft surface.
Install only on a hard and level surface.

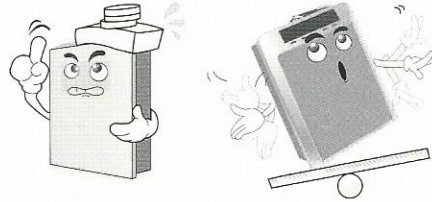

Maintenance Precautions



Always unplug your ionizer when changing the fuse or cleaning your ionizer
- failure to do so may result in electric shock.



Common Sense Precautions



Do not attempt to repair or service the unit yourself. Contact your dealer.
Attempting to do so will void your valuable warranty!



Make sure to use your ionizer only with potable water which is suitable for human consumption.



DO NOT use your ionizer with well water, water with extreme hardness, high sediment or TDS levels without first consulting your dealer.

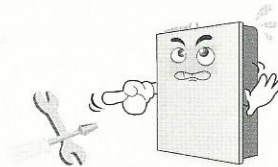

Safety Precautions



During Use



Do not run hot water through your ionizer.

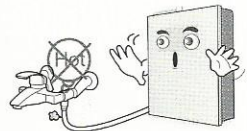

Do not clean by pouring water over or spraying the ionizer.

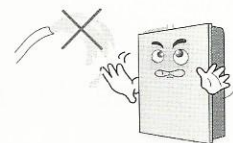

Do not close, bend, pinch, press or otherwise obstruct output ports or hoses.

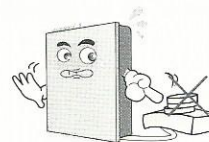

If the appliance makes strange or unusual noises or burning smells are detected, unplug the power cord immediately and contact your dealer to arrange service.

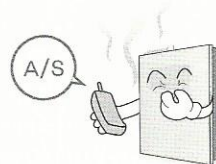

Unplug your ionizer if you plan not to use it for an extended period or turn off the main power switch on the back of the unit. Filter replacement may be necessary.

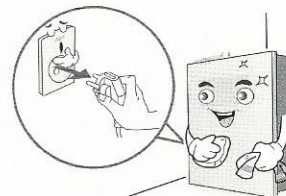



pH Reagent Liquid Precautions



Do not expose the pH measuring reagent to extreme heat, flames or fire. It is combustible.

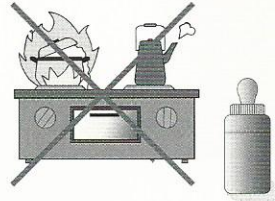

Do not drink the pH reagent liquid, put it in the eyes or apply to the body.

- If the liquid is ingested, induce vomiting immediately and call a doctor.
- If the liquid gets in the eyes, flush immediately and thoroughly with cool water; call a doctor.
- If spilled or dropped on your body, wash it off immediately.



Make sure to keep the pH reagent liquid tightly closed and out of the reach of children.



Some helpful tips



For storing your alkaline water, glass or ceramic is best. Always try and keep your stored water cool and away from direct sunlight. You can use plastic, but only use lexan (number 7) or poly bottles (Nalge type). It is always best fresh out of the machine and ideal if consumed on a day-to-day basis.

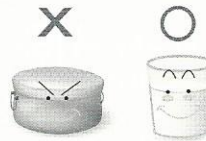

Do not store alkaline water in stainless steel, bronze or aluminum containers.



Save the box and Styrofoam your ionizer came packed in. This will help if your ionizer needs to be transported at a later date.



Do not use an ionizer downstream of a sodium-based ion exchange softening system or Reverse Osmosis system without first consulting with your dealer.

Names and functions of Parts I

Front

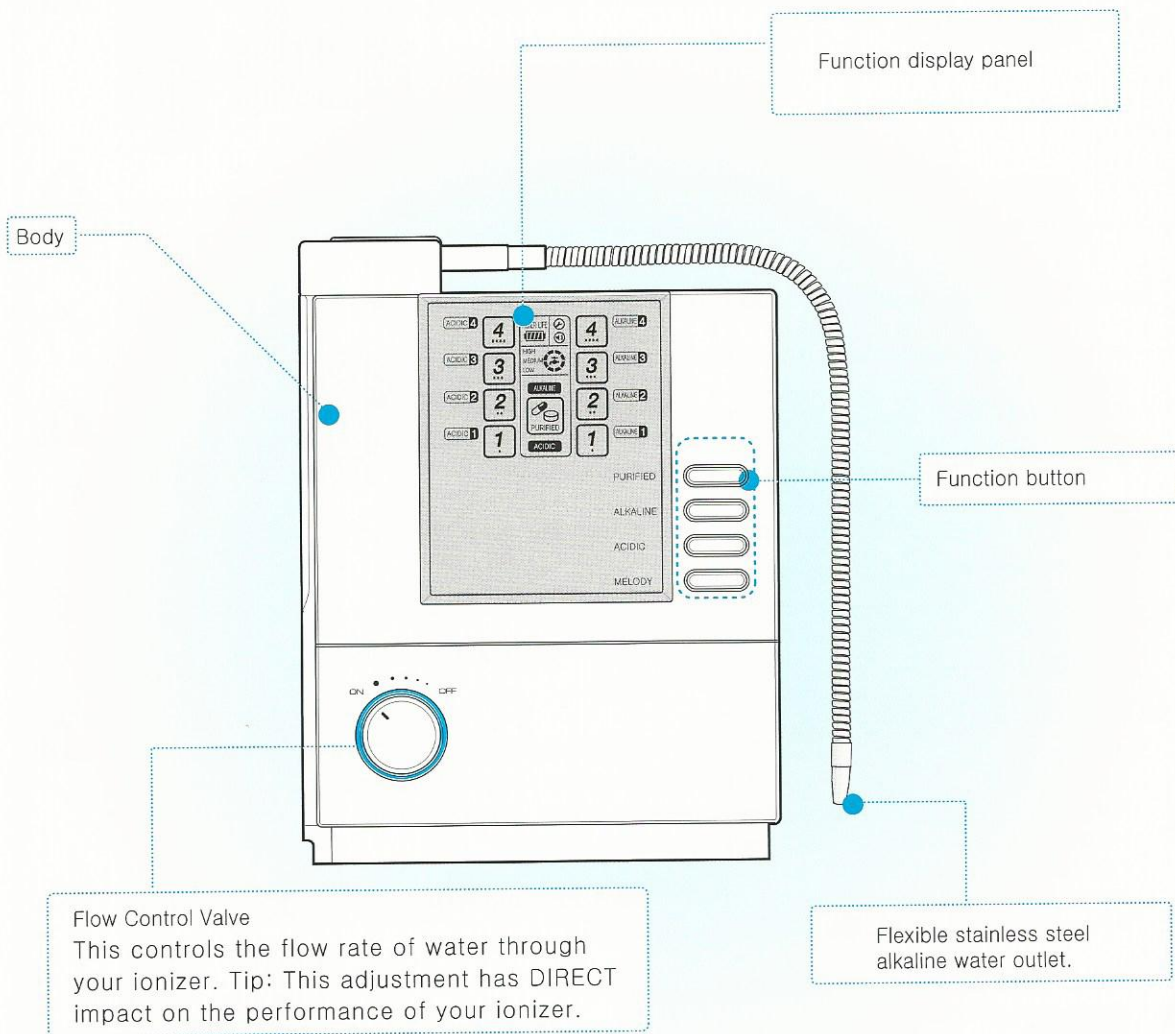

Back

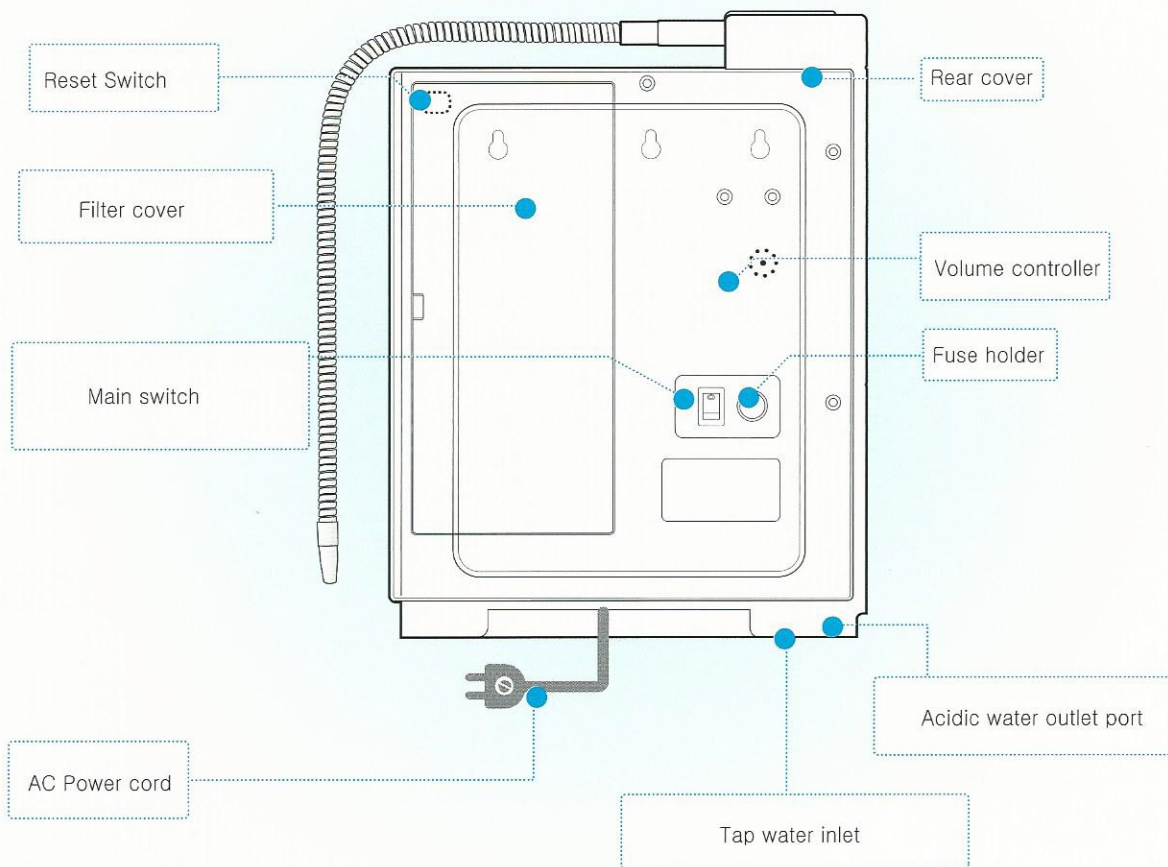

Names and functions of Parts II

Indicators

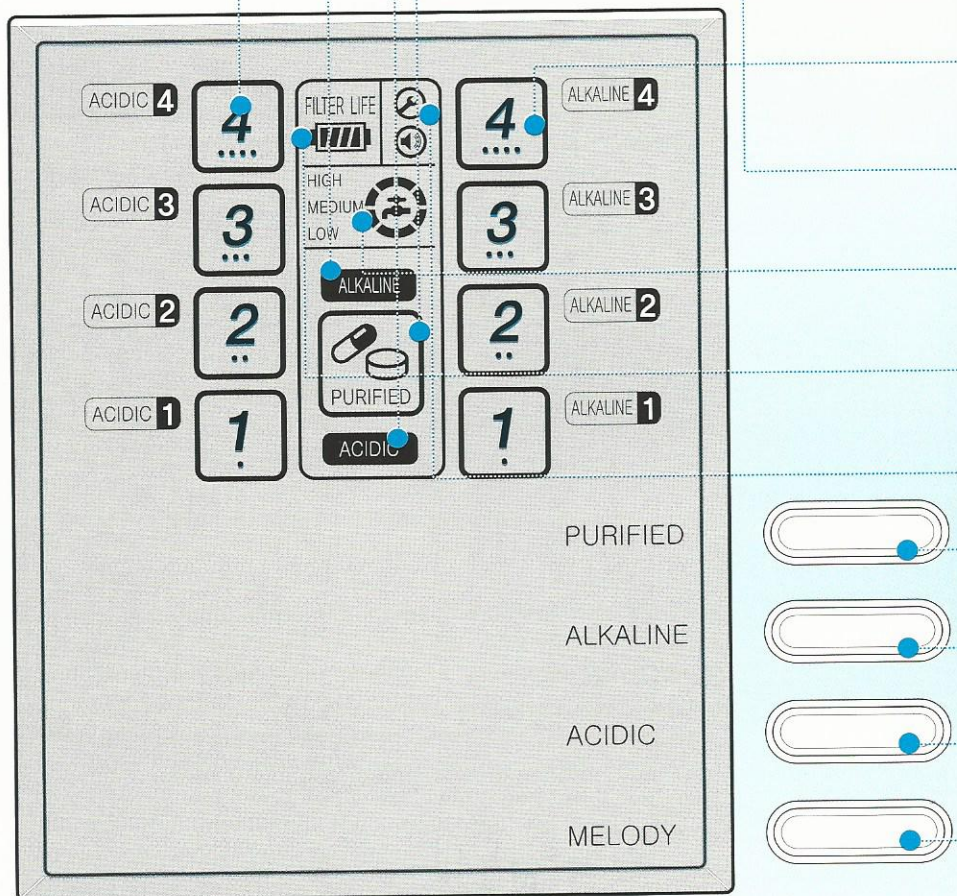

Alkaline water display indicator

The Alkaline indicator will light when alkaline water is selected.

Acidic water display indicator

The Acidic indicator will light when acidic water is selected.

Purified water display indicator

The Purified indicator will light when purified water is selected.

Alkalinity pH indicator

An Alkaline symbol shows which level of alkaline water is selected.

Acidic level indicator

An Acidic symbol shows which level of alkaline water is selected.

Flux indicator

Indicates the water flow in your ionizer.

Filter life indicator

Counts filter usage in a LED display.

Caution light

When this light is lit the appliance needs to be serviced.

"PURIFIED" water button

Used to select purified water.

"ALKALINE" water button

Used to select alkaline water and the desired level (1-4)

"ACIDIC" water button

Used to select acidic water and the desired level (1-4)

"MELODY" button

Turns the sounds On or Off. Additionally, the volume can be adjusted on the back.

How to Install

How To Install

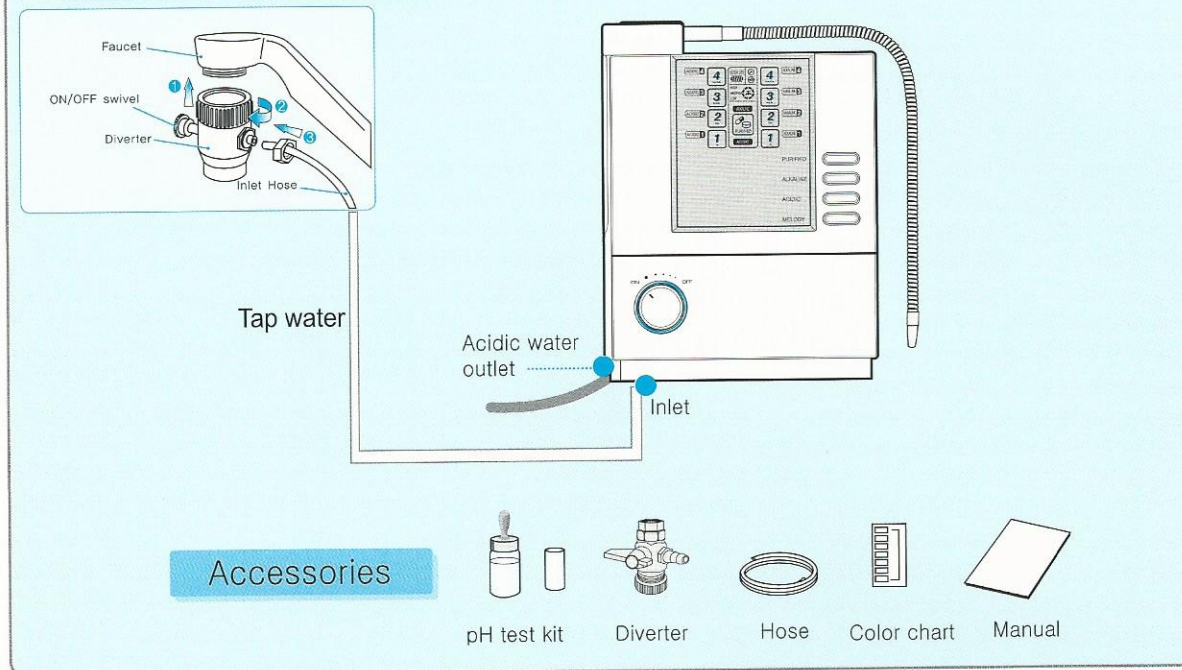

Installation Method – At the sink with a diverter

1. ATTACH DIVERTER TO YOUR TAP – Remove the aerator from tap (pliers may be required), and attach diverter valve in its place. There are adapters supplied in case the diverter does not fit your tap. If you have leaks at the diverter, use plumber's Teflon tape. (Image No. 3)
(We are now including Teflon tape in ionizers. Please use this..)

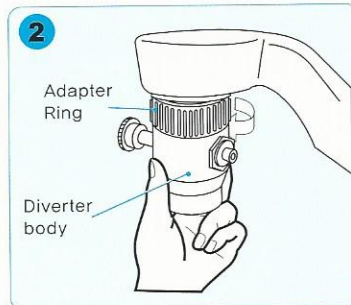
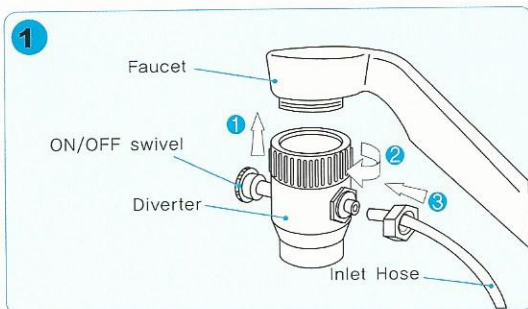

2. ATTACH THE WHITE TAP WATER INLET HOSE – Attach one end of the white hose to the gray port on the bottom of the ionizer labeled "TAP WATER INLET". To attach the white hose, simply push it firmly into the opening on grey port. (If you need to remove it, press on the end of the fitting while pulling out).



3. ATTACH THE GRAY ACIDIC WATER OUTLET HOSE – to the white plastic port labelled ACIDIC WATER OUTLET on the bottom of the ionizer. First, slide a squeeze clamp over the end of the hose. Then attach the gray hose, by simply pushing it firmly over the white plastic port. Soaking it in hot water for 30 seconds will make attaching it very easy. Squeeze the clamp and position it over the white port. Ensure the opposite end runs into the sink.

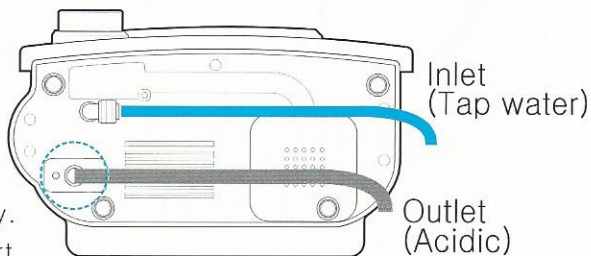

5. POSITION YOUR IONIZER – Ensure it is on a hard and level surface. A wall mount can be done – there are keyhole slots on the back for this.
6. ATTACH THE WHITE HOSE TO THE DIVERTER – Remove the small compression nut on the back of the diverter (opposite of the lever). Slide the nut over the opposite end of the white hose you attached to the TAP WATER INLET port with the threads positioned so it will screw it back onto the diverter. Push the hose firmly onto the nipple, then screw the compression nut back on. Ensure the nut is screwed firmly in place, but do not over tighten.

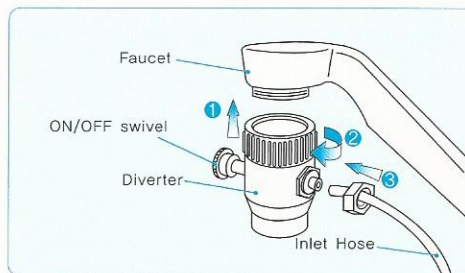

7. CONNECT THE POWER CORD to an appropriate GFI outlet.
8. INSTALL FLEXIBLE STAINLESS STEEL SPOUT – Screw this into the threaded port on the top of the ionizer. Do not over tighten.

How to Use

1. POWER UP YOUR IONIZER.

- Depress the black power button located on the back of the ionizer to the "ON" position.
- The black power button is ALWAYS left on. Your ionizer will "go to sleep" in between uses and "wake up" when it detects water flow again. It will always return to your last selected setting.
- You will hear a single chime and the display panel will illuminate for 2-3 seconds.
- With the power on and the display panel dark, your ionizer is now in standby mode.



2. START WATER FLOW THROUGH YOUR IONIZER

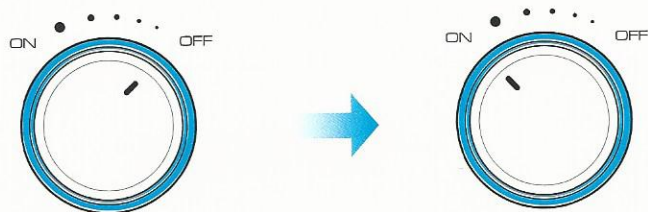

- a. SET THE FLOW CONTROL VALVE - This control is on the front of machine and has an "ON" and "OFF" position. Try initially setting this half way between "ON" and "OFF".

This control WILL DIRECTLY impact the performance of your ionizer.
A slow flow will yield higher pH; a fast flow will yield lower pH.

- b. Turn on your water faucet. Turn the lever to until you "divert" the water through your ionizer.
- c. Get the feel for the difference in flow rates by adjusting FLOW CONTROL VALVE from a slow trickle to the fastest flow. When you begin ionizing the water, start with it in the medium range and adjust faster or slower as necessary to achieve optimum results.

CAUTION

After 20 liters of water have flowed through the JP107 units, it will do an autoclean for 10 seconds.

For example, if the ionizer is used first for 15 liters and then is used for 5 liters, upon the next use, the unit will do an auto clean for 10 seconds.

TO SELECT ALKALINE WATER

1. With water running through the ionizer:
2. Depress the "ALKALINE" button to select the desired setting from 1 – 4.
You will hear voice confirmation that "Alkaline water" has been selected, and the LED Control Panel will be back-lit. The Alkaline Water Indicator will light showing the level you have selected.
3. Note: Your ionizer will always "remember" the last setting used. If the previous selection was Alkaline Level 2, when you start the ionizer the next time, your ionizer it will automatically process at the same Alkaline Level 2.
4. To select a different level, depress the "ALKALINE" button to move to next level until the desired setting level is achieved. The Alkaline Water Indicator will change accordingly.

IMPORTANT NOTES:

- ⚠ If you have never consumed alkaline water – do not use a setting higher than 1 to begin with. Let your body adjust slowly and naturally for 4–7 days. After this initial adjustment period, you may gradually increase the alkalinity of the water.
- ⚠ pH levels will vary according to the minerals present in the source water and water flow rate through your ionizer.

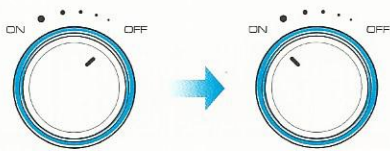

ALKALINE

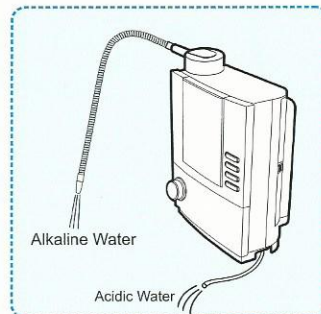

Level 1
Alkaline Water

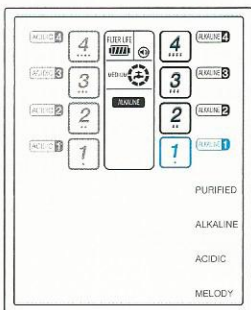

Level 2
Alkaline Water

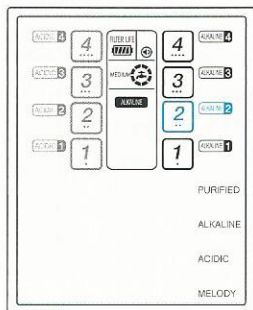

Level 3
Alkaline Water

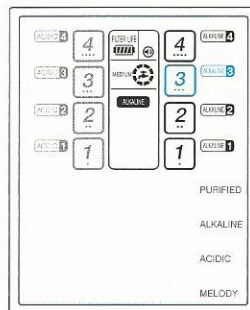

Level 4
Alkaline Water

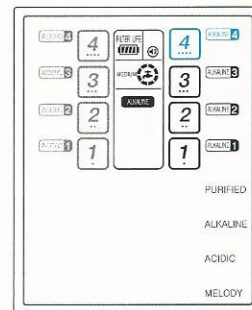

How to Use

SELECT ACIDIC WATER

Note: Acidic water is for external use only. **DO NOT DRINK.**

1. With water running through the ionizer:
2. Depress the "ACIDIC" button to select the desired setting from 1 - 4. You will hear voice confirmation that "Acidic water" has been selected, and the LCD Control Panel will be back-lit. The Acidic Water Indicator will light showing the level you have selected.
3. Note: Your ionizer will always "remember" the last setting used. If the previous selection was Acidic Level 2, when you start flow through the ionizer next time you use the ionizer it will automatically process at Acidic Level 2.
4. To select a different level, depress the "ACIDIC" button to move to next level until the desired setting level is achieved. The orange symbol and number will change accordingly.

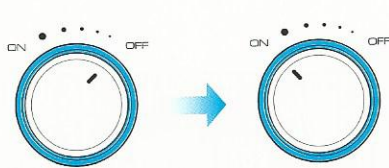

ACIDIC

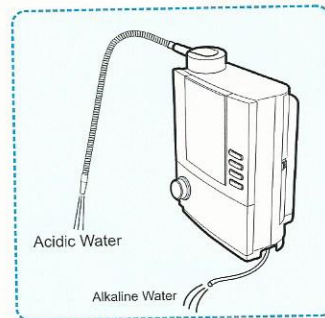

Level 1
Acidic Water

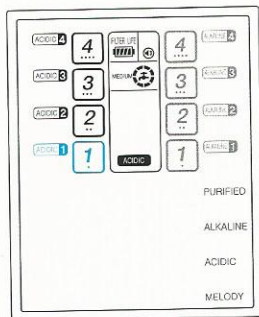

Level 2
Acidic Water

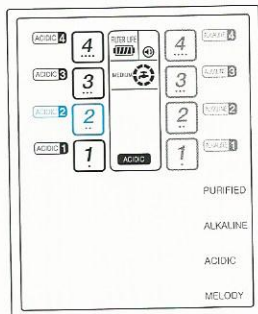

Level 3
Acidic Water

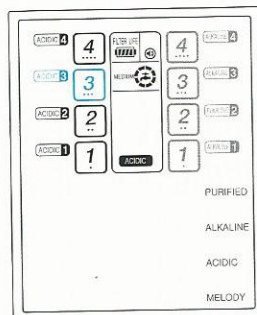

Level 4
Acidic Water

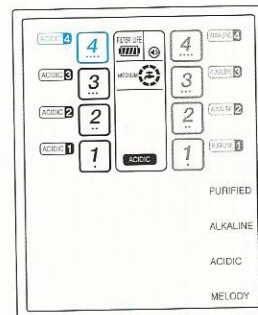

SELECT "PURIFIED" WATER

With water flowing through the machine, depress the "PURIFIED" button.
The purified water runs through the Biostone filter, but does not receive any ionization.
You will hear a voice confirmation that "Purified water" has been selected, and the LCD Control Panel will be back-lit.
The Purified Water Indicator will be illuminated.
The purified water comes out of the stainless steel spout.

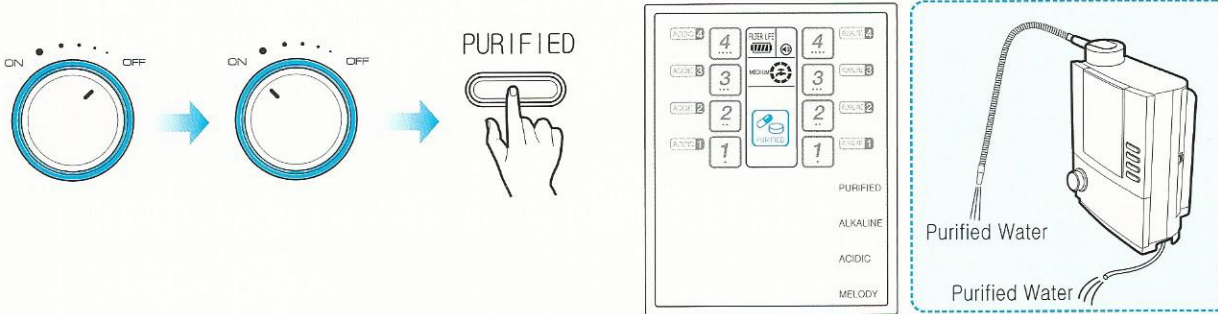

HOW TO SHUT OFF THE WATER FLOW FROM YOUR IONIZER

Rotate the diverter lever until the water flow from the ionizer stops and reverts to the faucet.
The water will stop and the display panel will go dark indicating the ionizer is in standby or "asleep".



HOW TO MUTE THE SOUND

With water running through the ionizer, depress the "MELODY" button.
All sounds except for the chime sounds will be muted. All sound volume including the voice and the chime sound (with or without voice muted) can be adjusted by manipulating the Speaker Volume control located on the back of your ionizer with a small Phillips screwdriver.

MELODY



What is alkaline electrolyzed-reduced water?

What is alkaline electrolyzed-reduced water?

You can get alkaline/acidic electrolyzed-reduced water by electrolyzing the water after filtering impurities. Alkaline reduced water is the optimal water for health because it is rich in minerals including calcium. Acidic water is good for skin.

Some uses for the different levels of Alkaline Water



1

For initial consumption period (4-7 days). Let your body adjust slowly to the increase in pH. Many people find that this lower level is actually perfect for them.



2

After the adjustment period you can drink the water at this next level. This level is also great for cooking rice and other grains - fluffier and great tasting!



3

Some people like this for drinking though it can start to taste strong. It is superb for making tea or coffee as it enhances the taste and reduces bitterness!



4

Generally most people find this very strong tasting and with powerful detoxifying effects. Great for boiling vegetables! Alkaline water will eliminate the bitter taste and brings out more of their natural color.

What would I use the Filtered Water for?



The pH of Purified water is neither raised nor lowered and would be the same as your tap water. This water is simply cleaned of impurities by the advanced filtration system. You can use it both as drinking water and to take medications with.

Some uses for the different levels of Acidic Water

The Acid water has both antiseptic and antibacterial properties. It also has an astringent effect and can be used for cosmetic purposes.



1

Use it while brushing your teeth, gargle with it and use it as a natural mouth wash!



2

It is an excellent astringent: use it for washing your face or as a natural after shave.



3

In the kitchen use it to help clean kitchen utensils.



4

This setting has sterilizing properties – use it to sterilize cutting boards, dish towels etc...

Precautions for use of Alkaline water – don't develop a "drinking" problem!

- If you have never consumed alkaline water – do not use a setting higher than 1 to begin with. Let your body adjust slowly and naturally for 4–7 days. After this initial adjustment period, you can gradually increase the alkalinity of the water.
- Do not take medications with alkaline water. Take medications only with purified water.
- Consult with a physician before drinking alkaline water if you have:
 - Chronic disease
 - Are currently under medical treatment
- Do not drink alkaline water if you have achlorhydria.
- Consult a physician before using acidic water if you have:
 - Sensitive skin
 - Allergies
- Only use potable drinking water in your ionizer.
- Poor water quality may have negative effects on your health and your ionizer! Most municipal water sources will be fine in your ionizer.
- Well water and water from smaller systems should be checked, and may require pre-filtering. Your ionizer is not under warranty for any damage or required cleaning caused by hard water deposits.

How to Measure pH



How to Measure pH

- 1 Fill one of the test tubes provided about 1/4 full with alkaline, acidic or purified water.

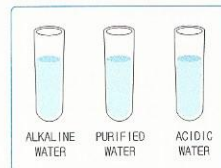

- 2 Drop 2 or 3 drops of the pH reagent into the container and shake it.

If the reagent and water are not mixed well, the correct result may not be displayed.

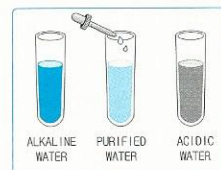

- 3 The pH value is determined by matching the color the pH color chart provided.

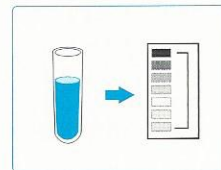

Important Note: Water quality and mineral content vary greatly in different localities and will directly impact performance of your ionizer with respect to pH.

NOTE :

Please rinse the glass tubes out thoroughly before each use for accurate pH value result.



- DO NOT consume water containing reagent
- Keep the pH reagent liquid, color chart, and test tubes away from direct sunlight
- KEEP pH reagent liquid AWAY FROM CHILDREN and OPEN FLAMES!
- For contact with eyes, flush liberally with fresh water, seek medical help
- If ingested, induce vomiting, seek medical help

How to Replace the Filter

How to Replace the Filter

IMPORTANT! Stop water flow prior to filter replacement.

- 1 When the digital filter life indicator reaches full or you see the flickering filter symbol, it is time to replace your filter.

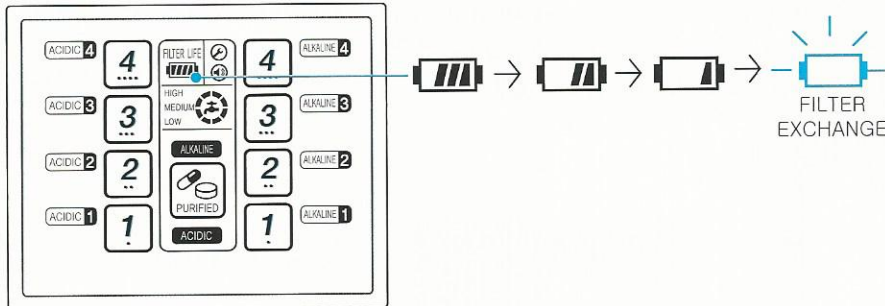

- 2 Stop water flow prior to filter replacement.



- 3 Open the filter housing cover.

–Push in on the plastic ridges in the center of the filter housing cover on the side while pulling the door out and to the left. Swing door out and remove it.

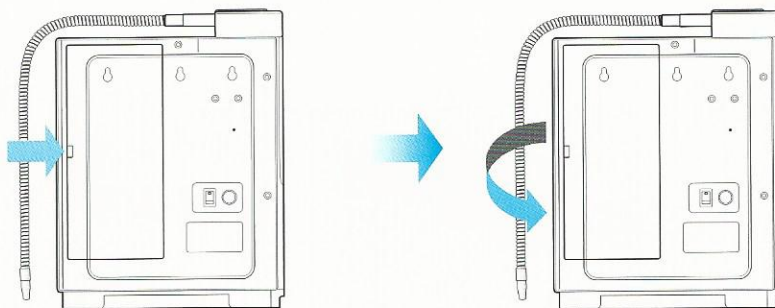

How to Replace the Filter

4 Remove the expired filter.

- Taking hold of the filter securely with your right hand, press the filter firmly down against the spring loaded mechanism to disengage the top of the filter and then lean the filter out toward you and lift up to remove it.
- The upper part of the filter is separated from housing by pressing firmly down. Once you have engaged the spring loaded mechanism, you can then easily remove the filter from the main body by leaning the filter out toward you and lifting up to remove it.

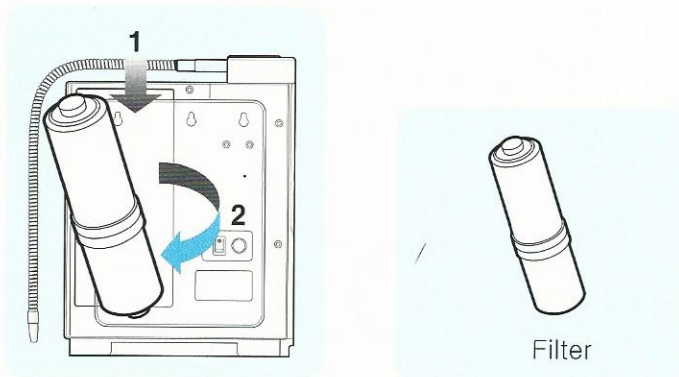

5 Insert the new filter into the compartment.

- Remove the plastic caps covering both ends of the new filter.
- Seat the large opening on the bottom of the filter cartridge onto the base.
- Push the filter down and into the housing compartment ensuring the opening at the top of the filter is seated properly into the fitting at the top of the housing

Check for leaks by running water through your ionizer before replacing the housing cover.

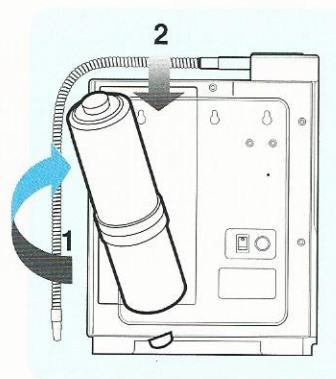

- 6** Flush out the GAC carbon dust.
- The water will initially come out discolored (light to charcoal gray) due to carbon particulates in the new filter. This is not harmful and is typical of all GAC filters. Allow the water to flow for 2-3 minutes in the "Purified" mode and this will flush all the carbon dust.

Immediately after filter replacement, the water will come out black and unclear due to the activated carbon particulates in the new filter but will become clear momentarily. (It is not harmful.)

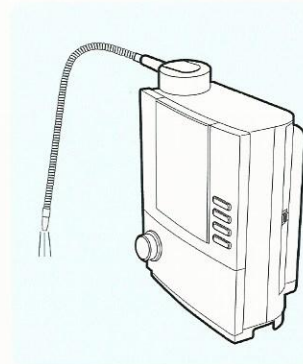

- 7** Reset the filter life indicator.
- With your ionizer in standby mode (water not running through the ionizer) press the "Reset" button located at the top of the filter housing compartment for 3~5 seconds.
 - Replace the filter housing cover.

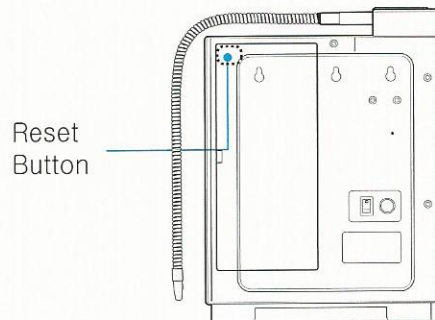

WARNING INDICATORS

- 1) **LOW PRESSURE** – The Low Pressure Warning indicator will flicker when water flow or pressure into the machine is weak. Increase the water flow to resolve this condition.
- 2) **HOT WATER** – The Hot Water Warning indicator will flicker when you have inadvertently run hot water into the machine. Switch back to cold water immediately to resolve this condition. Allow the cold water to flow for about a minute.

Filter Composition

Composition of filter

Calcium:

It slightly increases the alkaline mineral content in your water. It improves water taste and odors, You get calcium on tap!

Tourmaline:

Tourmaline emits Far Infra Red (FIR) energy naturally. FIR produces well documented health benefits and it also has an amazing effect on water.

The Biostone contains the semi -precious gemstone tourmaline in ceramic form, so you get FIR on tap!

Non-woven fabric filter

Filters out sediment and particulate.

Granular Activated Carbon (GAC) :

The workhorse of the filtration media. GAC is especially effective at removing chlorine, its odor and taste, agricultural chemicals, phenol, trihalomethane and other chemical contaminants. Silver is impregnated into the granular activated carbon to inhibit bacterial growth in between use.

Non woven fabric filter :

Filters out sediment and particulate.

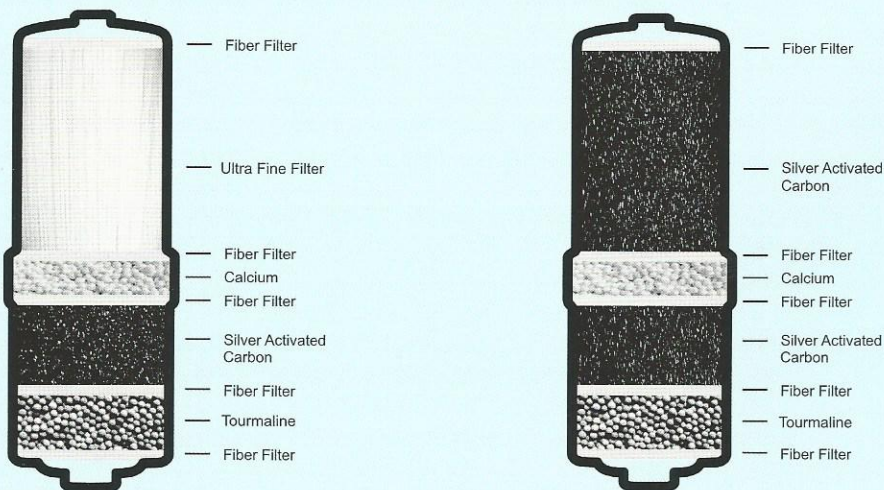

Water Flow Diagram

Flow Diagram

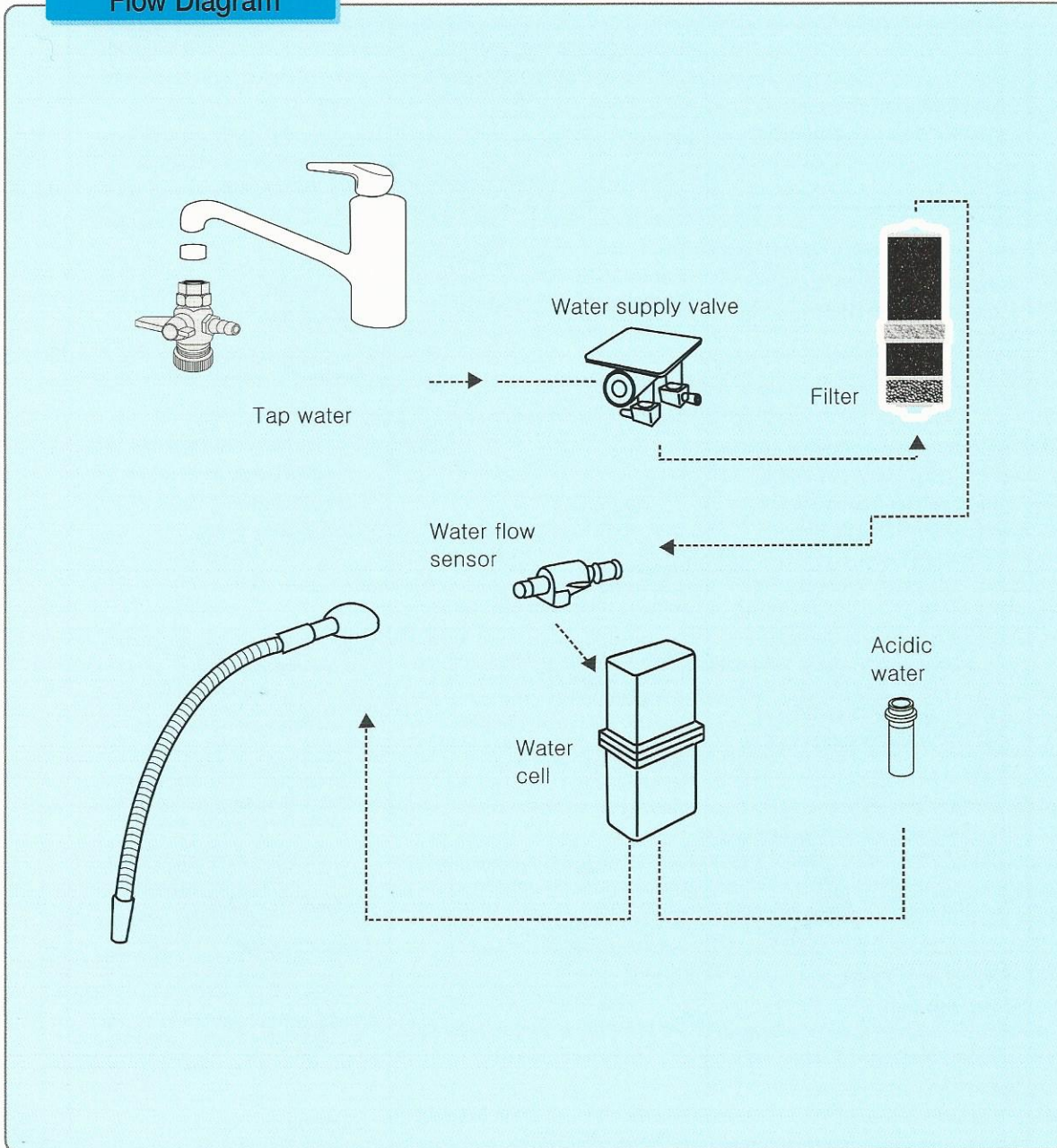

Trouble Shooting Guide

Abnormal condition	Cause(s)	Resolution
The Function Display Panel does not come on.	A power plug is not properly inserted, or it is inserted into a faulty outlet.	Properly insert power plug into a correctly functioning power outlet
	The fuse is blown. The fuse is not inserted properly.	Replace the fuse. A spare fuse is included in your reagent kit. (3A / 250V fuse)
The Function Display Panel / display indicators do not come on even after turning the tap on.	Faulty PCB (Printed Circuit Board)	Immediately unplug the unit and contact your dealer to arrange service.
pH test shows alkaline water color as neutral (7) while acidic water color gets yellow (6). This is normal if initial pH is 6.5	Faulty or evaporated reagent: alkaline / acidity are always produced in inverse proportion. Therefore, showing an acidic color means inversely that alkaline water has to be generated from the unit. Lack of alkaline color can result from a chemical reaction where carbonic acid in water evaporates some test reagent elements.	Test pH value on level 3 or 4 water; replace reagent.
Power supply is suddenly cut off while operating the unit.	Elevated level of salt in the water or high TDS; extended operation at high pH; sudden flux in electrical current. In these cases your machine will shut down automatically to protect the electrodes and circuitry.	Wait – the unit will become operational again after about one hour. Your ionizer has a safety mechanism built-in to protect the electrodes and circuitry. This mechanism will shut the ionizer down automatically. This mechanism protects the unit from overuse or excessive electric current.
Low output of alkaline water from the unit.	Filter is clogged. Premature clogging may be caused by sudden drop in water quality and an influx of sediment or other contaminants, which stress the filter.	Replace your filter. Clean Pre-filter
	Low pressure in your household plumbing.	Ensure water supply valves are fully open. The water pressure in house may be too low.
	The input hose is bent, kinked or otherwise restricted.	Straighten the bent hose.

Abnormal condition	Cause(s)	Resolution
Strange smell from Alkaline water.	Expired filter from ordinary use or premature clogging due to flux in water quality.	Replace your filter.
	Sudden flux in water quality with elevated level of Choline (not Chlorine). Elevated Choline levels are observed in some areas during summer months. These levels fall within safe drinking water standards, yet will cause a reaction with ionized water causing a unique smell.	Select lower pH level (1-2). If still present, filter replacement may be necessary.
Water appears milkish; white snow like particles in the bottom of your glass.	You have high hardness (calcium primarily) in your water. The white is extracted CaCO ₃ (Calcium carbonate). After CO ₂ in water is bonded with Ca where elevated levels of CO ₃ exist in your water. In water where elevated levels of CO ₃ exist, what you see after ionization is Ca ₂ in the water bonded with Ca.	This is calcium! It is not only harmless, but actually good for you. Remember the ionizer separates and condenses the alkaline minerals and this is what you are seeing. You can lower the setting (1-2) and reduce this effect. Typically this only occurs in hard water areas.
At first no smell, but then smell from the alkaline water about one hour after.	Your water bottle or receptacle is foul and needs cleaning. Contamination mixes with alkaline water when filling your bottle. Expired filter.	Clean your bottle or receptacle. Try selecting lower pH level (1-2). Replace your filter.
Water leakage from the filter cartridge housing.	Filter not installed correctly into filter housing.	Remove your filter and reinstall it properly following the filter replacement instructions. Increase the quantity of source water inflow.
No acid water flow from the acidic output port.	Acidic output hose is bent, kinked or otherwise restricted.	Straighten the bent hose; increase water flow from supply.

Product Specification

Product Specifications		
Product Manufacture Permission Number		No.1800 by Korea Food & Drug Administration
Feature		Ion water generator
Model		NW-110
Input voltage		230V/50Hz
Input Electricity(Power consumption)		0.5A
Weight		Approx 6.5kg
Overall Dimention		356 X 272 X 160 (mm)
Applicable Water Inflow Pressure		0.7~5kg/cm ²
Applicable Water Temperature		5~30 °C
Unit Operation Type		One Touch - Automatical ionization Start
Unit Operation Means		Tap - water - open and - close
Electolysis Device	Electrolysis Method	Continuous electrolysis
	Electrolysis Strength	4 level
	Ionized Water Output Rate	Max 3 Liters/minute(alkaline+acidic water)
	Cleaning Device	Automatic Cleaning (Every times cleaning)
	Electrode Materials	Platium and Titanium
Water Purifying Device	Filter Replacement	Easy replaceable cartridge
	Filter Life	Activated Carbon filter:approx 5~6 months basic 20 Liter/day
	Filter Life Indicator	FND indicator
	Filter Composition	Silver impregnated Carbon
Water Purifying Device		Temperature sensor / Auto Shut off
Water Supply		Direct connection to a top