

HOW JP-102

- Convenience in replacing filter
- Realizing the diversity with the high quality filter
- Use of platinum titanium
- Selecting flow meter



Water Ionized System

New substance generator for medical use

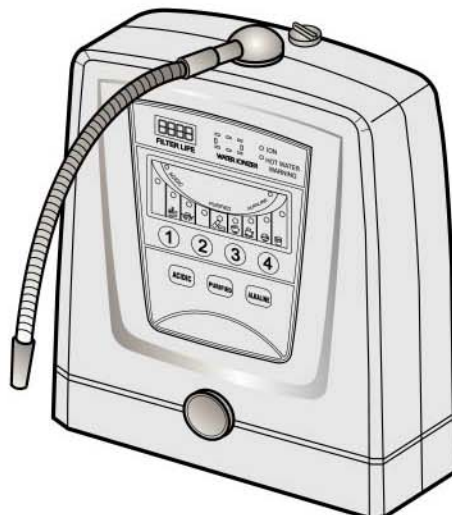

Make sure to read this Manual and Warranty Statement to correctly use the product. Thereafter, keep them in safe place for future reference.



PREPARATION FOR SAFETY



WARNING

If a break down occurs, do not make a repair by yourself. Contact the place of purchase or A/S center.

Electric Power Relevance



When the main body is dropped in water, pull off the power plug and bring the main body out of the water.

- It may cause the electric shock.



Do not use the product where it exceeds the rating of outlet or electric wiring.

- If the excessive rating occurs with the over use of electricity, it may cause the fire by the overheating.

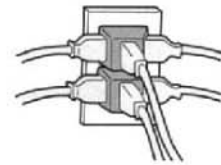

Do not touch the power plug with the wet hands.

- It may cause the electric shock.

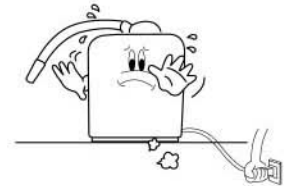

Push the power plus all the way into the outlet.

- If the insertion is not completed it may cause the electric shock or fire by the overheating.
- Do not use the damaged plus or worn out outlet.

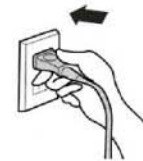

Unplug unit if you plan not to use it for an extended period or turn off the main power switch on the back side of the unit. unit should always be plugged into GFI electrical receptor in order to help protect against electrocution.

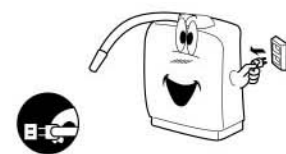

CAUTION ON UNIT INSTALLATION



Do not install in the place where water-freezing is possible.

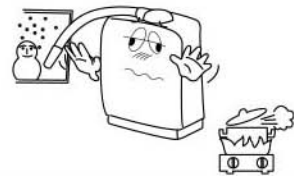

Keep the unit out of the direct ray of the sun.

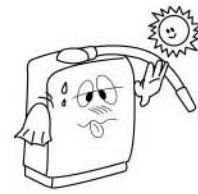

Do not put any heavy thing on the top of the unit.
Do not install in an unstable place.

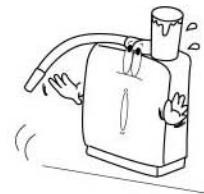

Caution-(Be cautious when in use)



Do not remodel the unit at your option.



Do not use the water that is permitted for consumption such as tap water.

- Since it does not have the sterilization capacity and not able to remove the harmful substances, it may worsen your physical condition.



PREPARATION FOR SAFETY



WARNING

- If a break down occurs, do not make a repair by yourself. Contact the place of purchase or A/S center.

Caution-(Be cautious when in use)



When use the product to assert the machine's own function, release the water accumulated inside.
(Run the water for 2~3 minutes)

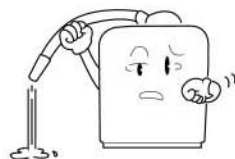

Do not use hot water or in-appropriate water for drink.

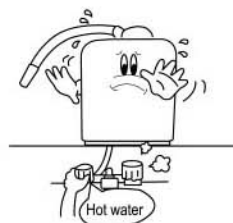

Do not manage for any water to be infilted into the inside of the unit.
Do not clean the unit with water.



Do not close, bend, wrench or press the ionized water output ports or hoses.

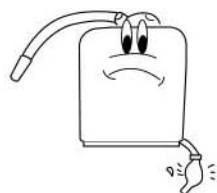

The others



Do not bring the pH measuring reagent near to the fire.
- It may cause the fire.
(No flames)



No fire



As for an alkaline ionized water-keeping container (or bottle), please use a container that is corrosion resistant such as glass, polyethylene(plastic) or ceramic ware etc.



3days-shelf (effective) period in case of keeping AKW in a closed container in a refrigerator, but drinking AKW within 1 day is recommended.



Do not drink, put in the eyes or apply on the body with the pH measuring liquid.
(Particularly for children)

- If the liquid is consumed by mistake, drink a lot of water to vomit it out, and if it entered into the eyes, wash off sufficiently with water and consult with a doctor immediately.
- In the event it is sprayed on the body, wash it off sufficiently.
Make sure to have the cover and keep it in a place where the children would not be able to reach.



EXTERNAL FEATURE AND FUNCTION

FRONT

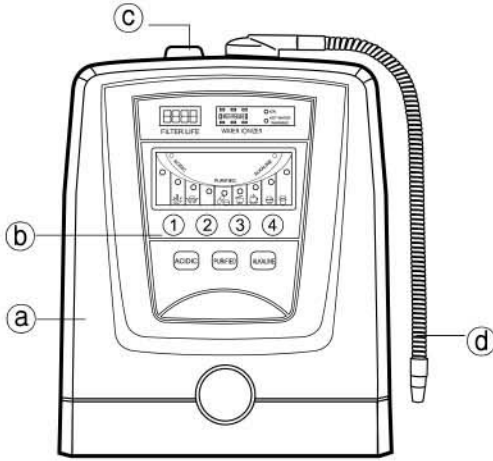

REAR

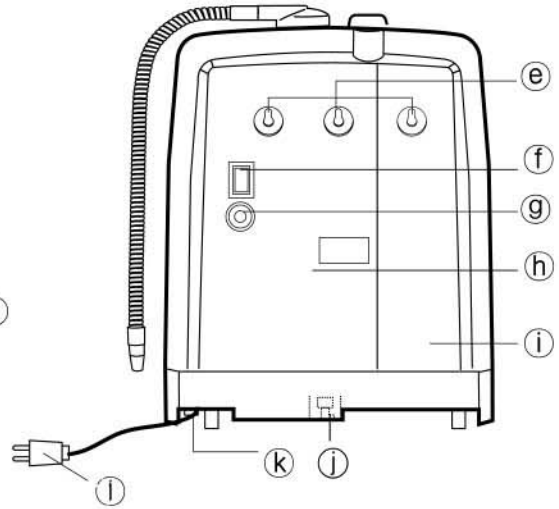

DISPLAY

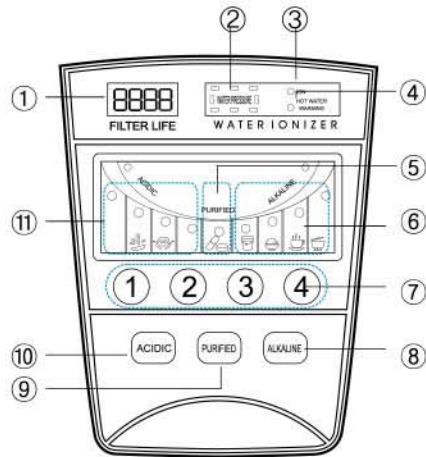
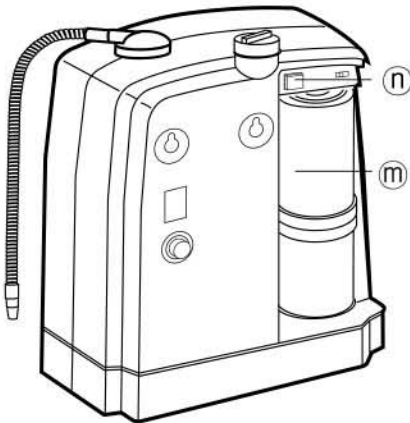

► Optional Tab Adaptors



Faucet Water Supply Valve



Flexible Hose



Operating Manual

Display

- a Main body
External casing embedding the machine and protects the internal components
 - b Function display panel
Eisplay function selections.
 - c Calcium container cap
Storage for pelletized calcium.
each load of calcium could last up to 4 weeks.
this is optional for consumers who require more calcium container
 - d Flexible stainless steel alkaline water outlet
Easily to dispense alkaline ionized water into an intened container.
 - e Holes for wall mounting
The machine may be safely mounted on to the wall. Please use suitable wall stud or drywall fastener if you wish to mount onto the wall.
 - f Main power switch
 - g Fuse holder
Preventing damage to machine in case of overloading.
 - h Back cover panel
 - i Filter cover
 - j Tap water input
Source water input.
 - k Acidic water output port
Output pathway of acid water generated during.
 - l AC Power cord
 - m Filter cartridge.
 - n Reset button
Whenever a new filter is replaced, please reset this button.
- ① Filter LED indicator
The machine is equipped with a sensor to detect the quality of source water and usage.
Digital number jumps accordingly and indicates the filter life usage with number progressing from 0000 ~9999. when the number reaches 9999, it is time to replace a new filter.
 - ② Water pressure warning LED indicator
When lighted up, it indicates insufficient water pressure for operation. A beep sound is activated. Do not operated machine in this mode because of overheating potential and higher than selected pH level.
 - ③ Ion LED indicator
When lighted up, indicates that ionization is in progress
 - ④ Hot water warning LED indicator
When lighted up, it ahs defected hot water passing through the machine.
switch to cold water immediately. Severe filter and electrodes damage may occur upon exposure to hot water.
 - ⑤ Water purifying indicator
Shows that function is for water purifying only.
 - ⑥ Alkaline pH level LED indicator
Lighted according to your selection of alkaline strength.
 - ⑦ pH button
 - ⑧ Alkaline ionic water button
Press this button to select alkaline water coming out from the flexible stainless outlet.
 - ⑨ Water purifying button
Press this button only if you just want purified water.
 - ⑩ Acidic water button
Press this button to select acidic water coming out from the flexible stainsee steel outlet.
 - ⑪ Acidic pH level LED indicator
Lighted according to your selection of acidic strength.

Accessories



pH solution



Hose



Hose Band



Adaptor



INSTALLATION PROCEDURE

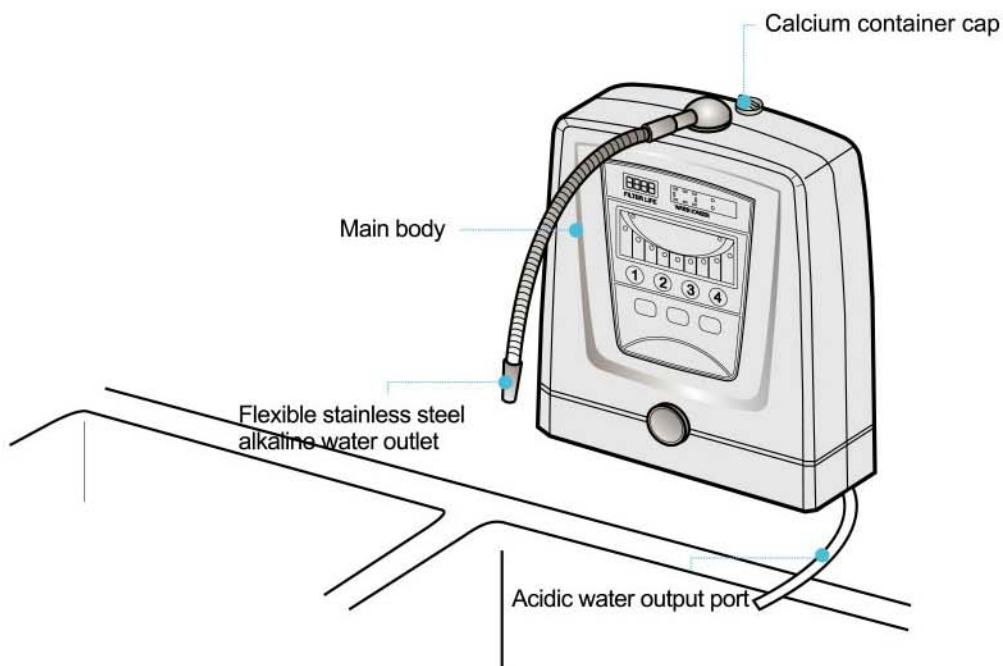

In case of wall-mounting location

- 1 Vertically attach the provided installation-guide paper on the wall after slightly pasting the guide paper with water



- 2 Nail down the studs on wall stud position as shown in the guide paper (1cm length of the studs should be remained).



- 3 Mount the ionizer unit on the wall by using the wall-mount holes on the back side of the ionizer unit.



Installation Method

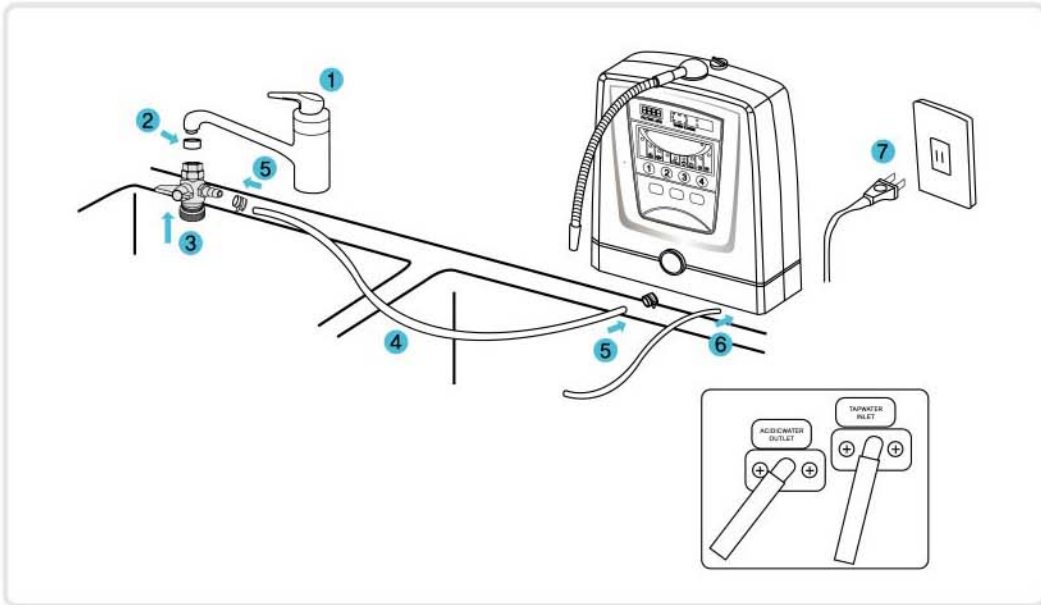

- 1 Turn off the water.
- 2 Screw in Stainless Steel tube to the top of the unit.
- 3 Remove aerator from the faucet and attach Faucet Diverter to Faucet. If you have threads inside the faucet (female threads) you will need a 15/16" Male Adapter (27 threads - 9D).
- 4 Cut plastic hose that comes with your Water Ionizer in half.
- 5 Attach one hose to the Faucet Diverter using a hose clamp at the end of the hose to leaks. Attach the other end to the bottom of the Water Ionizer marked INLET.
- 6 Place one of the hose clamps at the end of the INLET tube to prevent leaks. Attach the other hose to the bottom of the Water Ionizer labeled OUTLET and drape the tube into the sink.
- 7 Plug the unit into an electrical outlet.
- 8 Turn on the faucet and begin running water through the unit. The Water Ionizer will turn on automatically.



OPERATING PROCEDURE

Self cleaning

- 1 Switch on the main power switch behind the machine.

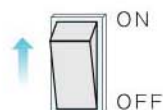

- 2 Along with the melody, the early washing is made for approximately 15 seconds. (For automatic washing, the alkali water comes from the acid water exit and the acid water comes from the alkali exit.)

* Depending on the functions the initial washing may not be released.

How to generate alkaline ionic water

- 1 Allow water to flow into the machine. Wait for the self-cleaning process to be over and then press the alkaline water button



- 2 The 3-phase indicator LED of the previously used in edge water(for example, 3-phase) is turned on and the alkali water comes off from the alkali exit and the acid water comes off from the acid exit.

Alkaline water comes out.

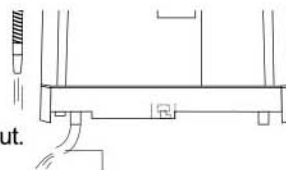

Acidic water comes out.

3

When the edge water is changed, press the pH selection button.
(The pH value may be changed depending on the water quality and water pressure.)

3rd phase-----Around 9.5

2 phase-----Around 9.0

1 phase-----Around 8.5

How to generate acidic ionic water

1

Allow water to flow into the machine and press the Acidic water button.



2

The 3-phase indicator LED for the previously used edge water (i.e., 3-phase) is turned on, the alkaline exit releases the acidic ionic water, and the acidic exit releases the alkaline water out.

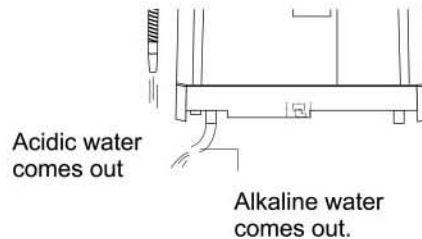



OPERATING PROCEDURE

How to generate purified water

This is the function to collect a massive volume of acid ion water to use as the water for washing face or bathing.

- 1 Allow water to flow into the machine and press the purified water button.



- 2 Press Purified water button for purified water only.

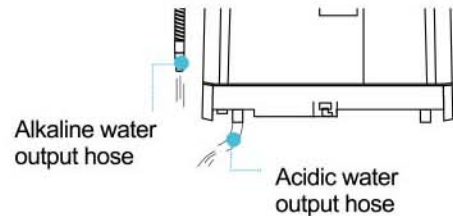

Use it when used for the water cleaning function and consumed for medical product. This is a function to use the water purifier without the ion separation. When using the water purifying function, the water supply value may be used without the turning on of the power button, however, the filter outlet volume can not be calculated that make sure the power is turned on to use. Depending on the pH value of original water, the value may exceed pH8.



Testing of pH value

Testing of pH value

- 1** Fill up 2/3 each test tube with tap water alkaline water and acidic water.

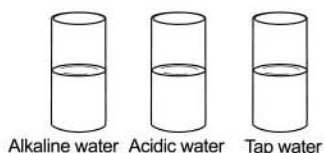

- 2** Drop 2 to 3 drops of the testing solution into each tube and shake it well.



- 3** Compare the color to the color chart provided.

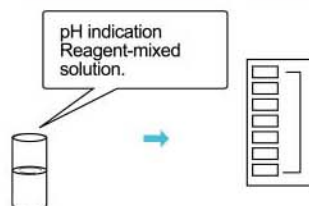

The water with pH measuring reagent shall absolutely not be consumed.

The pH measuring reagent and the pH value measuring chart are taken into the vinyl container and keep it in dark and cool area where the sunshine does not reach.

Avoid the area for children to reach or the place with fire







In the event that the pH measuring reagent touches eye and mouth, wash it off sufficiently with water.



Utilization of various kind of water from the ionizer unit.

Particula usage of ionized water

1~2 cups AKW on empty stomach every morning and 1~2 cups before daily bedtime will bring great efficacy. Drink 2~4 cups of pH 8.0~9.0 AKW everyday and increase the driking quantity with higher pH strength as your body gets assimilated with it.

	Strong alkaline water <i>10.0</i>	For cooking preparation. Good for extorting a bitter taste of vegetables. shorten cooking time. Use for washing vegetables and for boiling foods, and the color of vegetables and foods get more lucid and clearer
	Alkaline water <i>9.5</i>	Optimal for making barley tea and oolong tea. Can make tea softer and time it takes conventional water to make tea.
	Alkaline water <i>9.0</i>	To cook rice To make teas.
	Alkaline water <i>8.0</i>	Suitable for a beginner to AKW.
	Purified water <i>7.0</i>	For taking medications.
	Acidic water <i>6.0~3.0</i>	For skin care. After face washing, bathing and shaving. For cleaning of electrolytic cell.



[Anacidity: Anacidity is a symptom to have the functions of liver and gall to have shortage in secretion of bile or stomach acid and others, causing the indigestion of food]

General information



The persons who consume this for the first time should have a little volume for approximately two weeks by making pH close to neutral. Begin with weak alkali, raise the level gradually to the strong alkali and consume it.



Do not consume the medical product as the alkali water. Consume the medical product by generating in purified water.



The following persons should consult with a doctor or pharmacist prior to consuming it.

1. Person with chronic disease
2. Person who has ailment in liver and intestine
3. Person who is under a care of a physician



The following persons should consult with a doctor or pharmacist prior to consuming the acid water.

1. Person with vulnerable skin
2. Person with allergy



Use the appropriate water for the standard of drinking water as the original water. It may influence on the product and human body.



Persons of anacidity shall not consume the ionic water.



HOW TO REPLACE NEW FILTER

Turn off water supply

- 1** Pull and open the filter cover.
Press the right side of the center of the filter cover and pull it forward.



- 2** Pull the filter together and take it out.
While pressing down the filter and pull forward to take it out.



- 3** Insert the new filter from the bottom part.
Press the new filter downward and push it inside.
And insert it on the upper exit.



Accurately insert the o-ring not to be broken off.
Open the water supply valve to supply the water
in order to confirm whether the leakage
phenomenon occurs



4

Open the water supply valve while the power is turned off and run the water for approximately 2~3 minutes. When the filter is a new one, the water that runs first is dark and thick. This is the release of active dust in the filter that will be disappeared momentarily. (Not harmful to the human body.)



5

When the new filter is fitted, please allow water to run through for about 2 to 3 minutes with power supply off. You might observed an outflow of dark-colored water flowing out initially and when the water is clear, you can start to operate your machine.

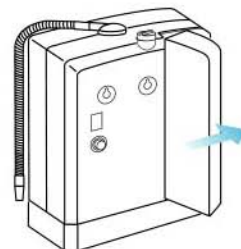

[Even if the filter replacement FND is not turned on completely, please replace the filter when any one of the following phenomenon occurs.

- When the severely polluted water is used to clog up the filter to allow much less water to run
- When excessively polluted water in flown in to have odor in the water
- When re-use it with not using it for a significant time.



INTERNAL FEATURE AND FUNCTION

1. Function

- **Realizing the complete automation with the built-in automation system**
 - artificial intelligent Mycom circuit
- **Alarm message function**
 - for low flow volume and hot water flow in, the automatic ion generation is suspended for the alarm message function
- **Cycle cycle calculation function for water purifier filter**
 - Calculate the life of accurate purified water filter by selecting the water meter
- **Early washing function**
 - when water is flowing in, it has the function of early washing

2. Flow Diagram

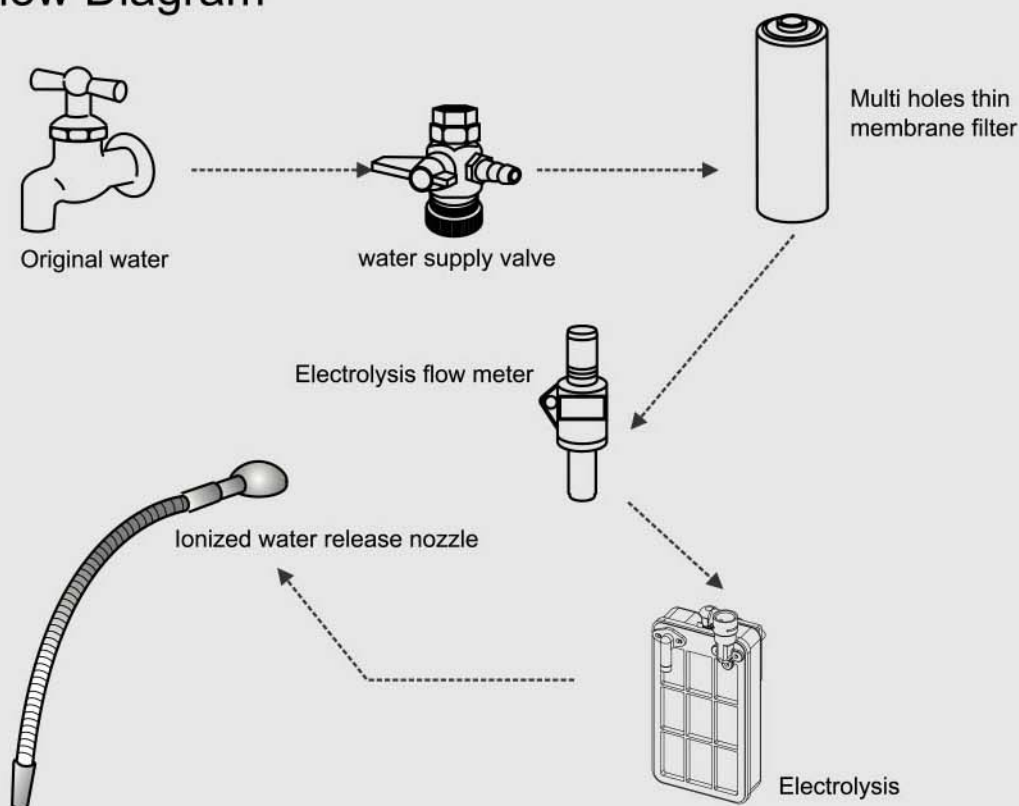

3. Composition of filter

5. Calcium

It removes the bad taste and bad odor in water, and it is particularly effective in removing the chloride.

4. Tourmaline ceramics

The molecule group of water is converted in small size of good taste water to be effective in removing the odor of germ effect

3. Non-woven fabric filter

2. Anti-germs granular activated carbon

It removes odor, taste, disinfectant, agricultural chemicals, phenol, trihalomethane and other chemical substance. Silver is coated on the surface of the granular activated carbon to control the breeding of germs.

1. Non-woven fabric filter

It filters the rust, wastes and floating substances with relatively large particles.

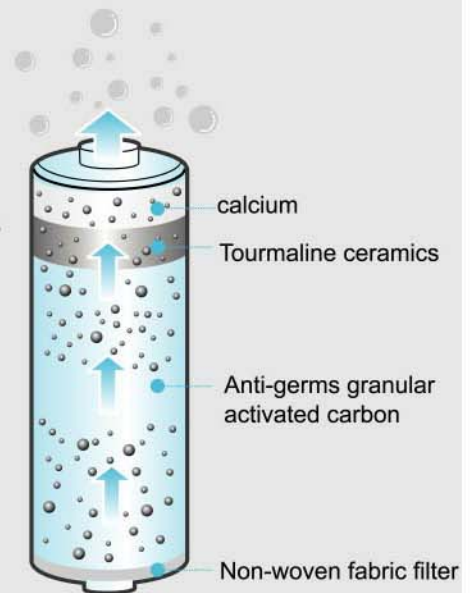



UNIT EXAMINATION & EMERGENCY TREATMENT

Abnormal condition	Cause	Treatment
Main Power lamp dose not come on.	A power plug is not property put in a socket.	Put a plug in a socket exactly.
	the fuse is blown. the fuse is not inserted propety	Replace the fuse (2A fuse against 110V)
Ionization lamp dose not come on even after turning the tap on.	Abnormality of PCB	Immediately unplug out of a socket and then bring the unit to a selling agent for A/S
On pH test with a reagent acidic water color gets yellow, but alkaline water color indicates pH neutrality	Alkaline is in inverse proportion to acidity. therefore, showing an acidic reaction means that inversely alkaline water is generated from the unit. No alkalinity color appearance result from a chemical reaction that carbonic acid in water evaporates some test reagent elements.	Test pH value with level 4 water.
Power supply is suddenly cut off during operating the unit	Too much salt in the water which cause overheating. TDS is much generated from subterranean water due to long time operation at high pH level.	It is not a mechanism. It is a mechanism to protect the unit from possible excessive electric current. The unit will automatically operate after some time interval.
Low output of ionized water from the unit.	Filter is clogged. Filter clogged may be caused by sudden inflow of seriously polluted source water.	Filter replacement is needed.
	Low inflow pressure.	Take a hose away from the divert adaptor connected to the water tab and make a divert adaptor hole larger
	The use hose is bent.	Straighten the bent hose.

Abnormal condition	Cause	Treatment
Strange smell from output water	Filter life is over. filter life can be extremely shortened in case the unit is exposed to bad quality water.	Filter replacement is needed.
	Due to sudden change of source water quality and too much Cl contained in the source water in summer season. Infinitesimal Cl may remain in output water as electrolyzed ion water has a strong activity and this Cl may cause a strange smell.	select pH level 1~2 lower pH strength. If still serious, filter replacement is needed.
Milk-water materials precipitate on the bottom of a ionized water receptacle (alkaline and acidic water)	It is extracted CaCO after Co in water is bonded with Ca in case much CO exists in water	It is totally harmless to our body. It gives a merely discomfort feeling to an user due to it's appearance, but please feel easy. In this instance, select pH level 1~2 lower pH strength.
At first no smell, but smell from the output water in about 1 hour after collecting ionized water	The water-keeping bottle or receptacle is foul. Contamination is added into the bottle when collecting output water from the unit. Filter is seriously polluted.	Check cleanliness of the water-keeping bottle considering ionized waer's molecule clustersize is much smaller. If so serious, then replace a filter and select pH level 1~2 lower pH strength.
Water leakage from a filter room	Abnormal with a filter packing. A filter is not fitted firmly at the base.	Take filter out, check the filter room and finally fit firmly thereto.
No output flow of generated water from the acidic output port.	Check whether the output hose is bent.	Increase the quantity of source water inflow. Straighten the bent hose.



PRODUCT SPECIFICATIONS

Product Specifications		
Product Manufacture Permission Number		No.610 by The Ministry of Health & Welfare
Feature		Ion water generator
Model		JP-102
Input voltage		AC110V60Hz
Input Electricity(Power consumption)		0.5A(80W)
Weight		Approx 5.5kg
Overall Dimention		265 x 140 x321 (mm)
Applicable Water Inflow Pressure		0.7~5kgf /cm ²
Applicable Water Temperature		5~30 °C
Unit Operation Type		One Touch - Automatical ionization Start
Unit Operation Means		Tap - water - open and - close
Electolysis Device	Electrolsis Method	Continuous electrolysis
	Electrolsis Strength	1 - 4 level
	Ionized Water Output Rate	Max 3 Liters/minute(alkaline+acidic water)
	Cleaning Device	Automatic & manual cleaning
	Electrode Materials	Platium and Titanium
Water Purifying Device	Filter Replacement	Easy replaceable cartridge
	Filter Life	Activated Carbon filter:approx 5~6 months basic 20 Liter/day
	Filter Life Indicator	FND Indication
	Filter Composition	Silver impregnated Carbon
Water Purifying Device		Temperature sensor / Auto Shut off
Water Supply		Direct connection to a tap

CERTIFICATE OF WARRANTY CARD

(Customer's Portion)

Name of Owner : _____

Address : _____

Product : _____

Serial Number : _____

Date Purchased : _____

Invoice Number : _____

(Note : The warranty is not transferrable. This portion to be retained by the customer and must be produced when service is required)

Sole Distributor : _____

CERTIFICATE OF WARRANTY CARD

(Sole distributor's Portion)

Name of Owner : _____

Address : _____

Product : _____

Serial Number : _____

Date Purchased : _____

Invoice Number : _____

Sole Distributor : _____

We provide a full year warranty effective from date of purchase against manufacturing Defects provided that machine is being used according to the operating instructions.

CONDITIONS : -

- 1) Under normal usage, if the machine breakdown, it shall be repaired free of charge during the warranty period.
- 2) This one year warranty does not cover the followings:-
 - a) Cleaning and replacement of filter.
 - b) Wrong usage of machine.
 - c) Damage caused by tampering and alterations or repairs made by unauthorized persons.
 - d) Damage cause by defective house wiring or by operating the machine on incorrect voltage or cycles or fluctuations or interruptions in the electric power supply.
 - e) Damage caused by transporting or moving the machine.
 - f) Machine improperly installed.
 - g) Ordinary wear and tear of parts.
- 3) This warranty is valid in Royal Water only.
- 4) This warranty is only valid provided purchaser send the 'Sole Distributor' portion of this warranty card duly completed to the Sole Distributor in Royal Water within 7days from date of purchase.

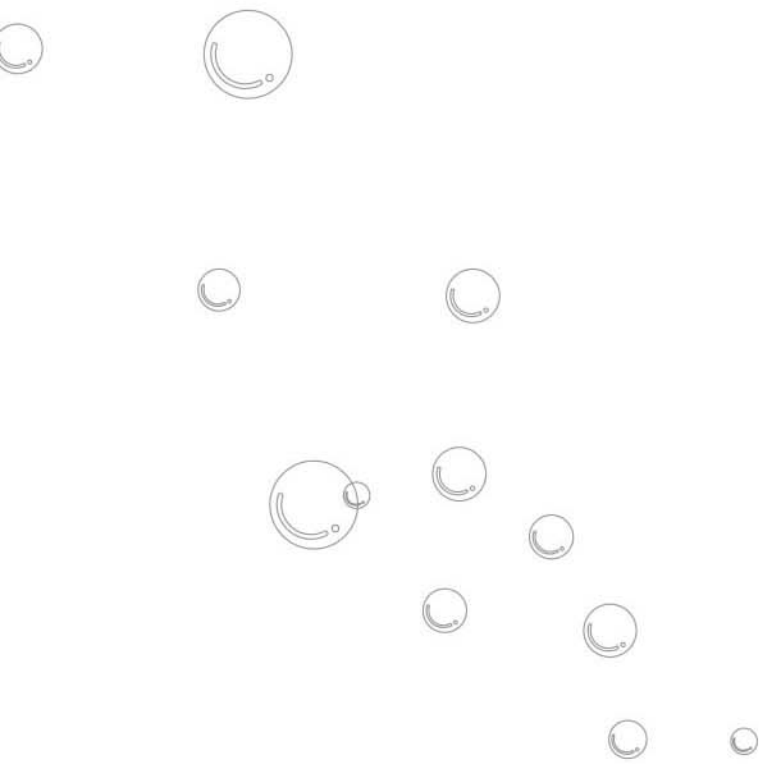

Importer;-