



# Delphi H<sub>2</sub>

## Owner's Manual



**Warning! Incorrect installation and/or operation could void your valuable warranty.  
Please protect your investment! READ THIS MANUAL CAREFULLY!**



**STOP**

## Read Me First / Quickstart Guide

- Step One:** Watch the Installation Video at [alkaviva.com/h2-videos](http://alkaviva.com/h2-videos)
- Step Two:** Test your Tap Water
- Step Three:** Install your Ionizer
- Step Four:** Enjoy your Water!

### IMPORTANT NOTES:

- If your ionizer is wet, some residual water be be present. Water is run through every machine for quality control and testing purposes.
- If you have well water - before you use your ionizer, it is critical that a water test is completed to ensure your water is potable (safe for drinking) and suitable to work with an ionizer. For testing, please visit: [alkaviva.com/professional-testing](http://alkaviva.com/professional-testing)
- AlkaViva recommends installation be performed by a qualified, licensed and bonded professional plumber or contractor. AlkaViva will not be held responsible for any damages caused by improper installation.

When having a professional install your ionizer, we recommend that you email [techsupport@alkaviva.com](mailto:techsupport@alkaviva.com) at least 48 hours in advance in advance to ensure a technician will be available during your installer's visit. Our office hours at 8 AM - 5 PM (Pacific Time), Mon - Fri.

- If you have a water softener, do not use your ionizer with a sodium or potassium based ion-exchange softeneing system without first consulting with your AlkaViva Associate or Technical Support.
- Iron causes major damage to your ionizer. Orange stains in your plumbing indicates iron in your water supply. If you have any indication of iron in your water supply, do not use your ionizer without first consulting with your AlkaViva Dealer or Technical Support.
- Remove the film on the display of your unit.
- Check your filters. They may have come loose during shipment. Refer to this Owner's Manual and check your filters prior to use.

**Should you require assistance with your ionizer, always fill out the ionizer repair and support form at:**  
[alkaviva.com/repairs](http://alkaviva.com/repairs)

**DO NOT ATTEMPT TO REPAIR YOUR WATER IONIZER! DOING SO WILL VOID YOUR WARRANTY!**





## Table of Contents

Congratulations on Your New Purchase.....	1
Important Safety Warnings and Precautions.....	2
How to Protect Your Investment & Warranty.....	3
Installing your Delphi H <sub>2</sub> Ionizer - At a Glance.....	4
Installing your Delphi H <sub>2</sub> .....	6
Operating Your Ionizer.....	8
Using Ionized Water.....	10
Uses for Alkaline / Acidic Water.....	11
Replacing the H <sub>2</sub> Series Smart Filter.....	13
Adding Optional Calcium or Scale Guard Inserts.....	14
How to Install Optional In-Line Sediment Filter.....	14
How to Operate your Quick Connect Fitting.....	14
Troubleshooting Guide.....	15





Delphi H<sub>2</sub> Series Manual  
Alkaline Water Ionizer  
And Hydrogen Generator

## *Congratulations on Your New Purchase!*

Your new H<sub>2</sub> Series ionizer is designed to provide you with many years of the cleanest, healthiest and most functional water available. There are many specific uses and benefits of this amazing water, so read this manual carefully to learn how to install, maintain, protect and get optimum performance out of your investment.

Your new H<sub>2</sub> Series Ionizer produces filtered alkaline, ionized, and hydrogen-rich water. Just exactly what is that? Your ionizer employs computer accurate and selectable magnetic energy to perform electrolysis through platinum titanium electrodes inside a water cell. Inside this advanced cell, the magnetic energy separates the water into alkaline (high pH) and acid (low pH) stream and enriches the water with dissolved molecular hydrogen without using any chemicals.

Ionizing the water also binds extra oxygen molecules, and concentrates ionized, absorbable and beneficial minerals like calcium, magnesium and potassium.

Your new H<sub>2</sub> series ionizer also produces acidic water. This type of water has a low pH (less than pH 6) and has many excellent uses. You now have the convenience and benefits of ionized water that functions in many ways that ordinary tap, filtered or bottled water simply cannot.

Enjoy your H<sub>2</sub> Series water ionizer!



## Important Safety Warnings & Precautions



**Prior to installation, it is very important that you read through and adhere to each of these safety warnings & precautions.**

- Always plug your ionizer into an appropriate outlet that is installed in accordance with all local codes and ordinances. Use a grounded outlet. Do not plug in your ionizer where it will exceed the rating of the outlet or electrical wiring. Failure to comply can result in fire, injury and/or damage to your electrical wiring, your ionizer, or yourself!
- NEVER attempt to repair or service the unit yourself. Attempting to do so will void your valuable warranty! Contact AlkaViva to arrange service or repair.
- If your ionizer becomes submerged in water, unplug the power cord from the wall before removing the ionizer from the water. Failure to do so may cause electric shock!
- NEVER touch the power cord or plug with wet hands - this may result in electric shock!
- Do not wash your ionizer by immersion or by pouring water over the main body; always unplug your ionizer while cleaning the casing. Clean with damp sponge or cloth.
- Ensure the power plug is firmly and properly inserted into the outlet - failure to do so may result in electric shock or fire!
- Keep the power cord and your ionizer away from hot surfaces or appliances - failure to do so may result in electric shock, fire, or damage to the ionizer!
- Never insert foreign objects into your ionizer.
- Do not operate your ionizer with a damaged power cord or plug or insert into a faulty or worn outlet.
- Always unplug your ionizer when changing a fuse or cleaning your ionizer. Failure to do so may result in an electric shock!
- Do not run hot water through your ionizer. Doing so will damage your filters.
- Protect your ionizer from freezing temperatures and direct sunlight.
- Install your ionizer only on a level, hard surface.
- Do not put anything heavy on top of your ionizer,
- Do not use benzene, paint thinner or insecticidal sprays for cleaning your ionizer. Doing so can damage the finish.
- Do not close, bend, pinch, press or otherwise obstruct output ports or tubing.
- If the appliance makes strange or unusual noises or odors, unplug the power cord immediately and contact AlkaViva Customer Service.
- Unplug your ionizer if you plan not to use it for an extended period. Store your filters in a plastic bag inside of your refrigerator to prevent bacterial growth. Filter replacement may be necessary when you use it again.
- Your ionizer is NOT under warranty for any damage caused by hard water.
- Do not use an ionizer downstream of any ion exchange water softening system or reverse osmosis system without first consulting AlkaViva Customer Service.
- Make sure to use your ionizer only with potable water which is suitable for human consumption.
- DO NOT use your ionizer with well water, water with extreme hardness, high sediment or TDS levels without first contacting AlkaViva Customer Service.

## How to Protect your Investment & Warranty

**Your H<sub>2</sub> Series includes a hard water test strip.  
Test your tap water BEFORE you install your ionizer.**

### Important! Hard Water Information

The H<sub>2</sub> Series ionizers have the most advanced cleaning system available, DARC II.





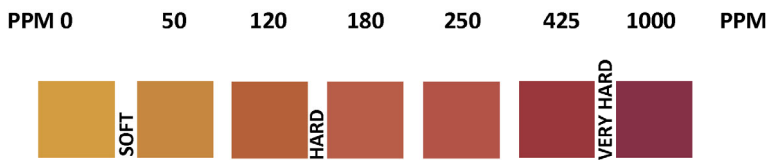

The DARC II cleaning system does an amazing job of protecting the critical components of your ionizer, but cannot reach all the internal plumbing inside of an ionizer. Which can also be susceptible to hard water damage called scale. Hard water damage will not only degrade performance, it will void your warranty.

To protect you and your ionizer, read the following information carefully and be sure to test your water.

#### Instructions:

1. Dip the hard water test strip into a water sample for 3 seconds.
2. Remove - DO NOT SHAKE.
3. Wait 20 seconds, and then match with the closest color block. Colors are stable for one minute.



If test strip is this color:	You need to order:
 50 ppm or less	We Recommend UltraWater Filter
 51 ppm to 120 ppm	EOS Scale Guard Inline Filter
 121 ppm to 180 ppm	
 181 ppm to 250 ppm	
 251 ppm to 425 ppm	AlkaViva Ultra Spartan
 Over 426 ppm	AlkaViva Reverse Osmosis System with Re-mineralizing Filter

If you have any questions, we're happy to help. Call AlkaViva at (775) 324-2400.

## Installing your Delphi H<sub>2</sub>- At a Glance

### Installation Diagram

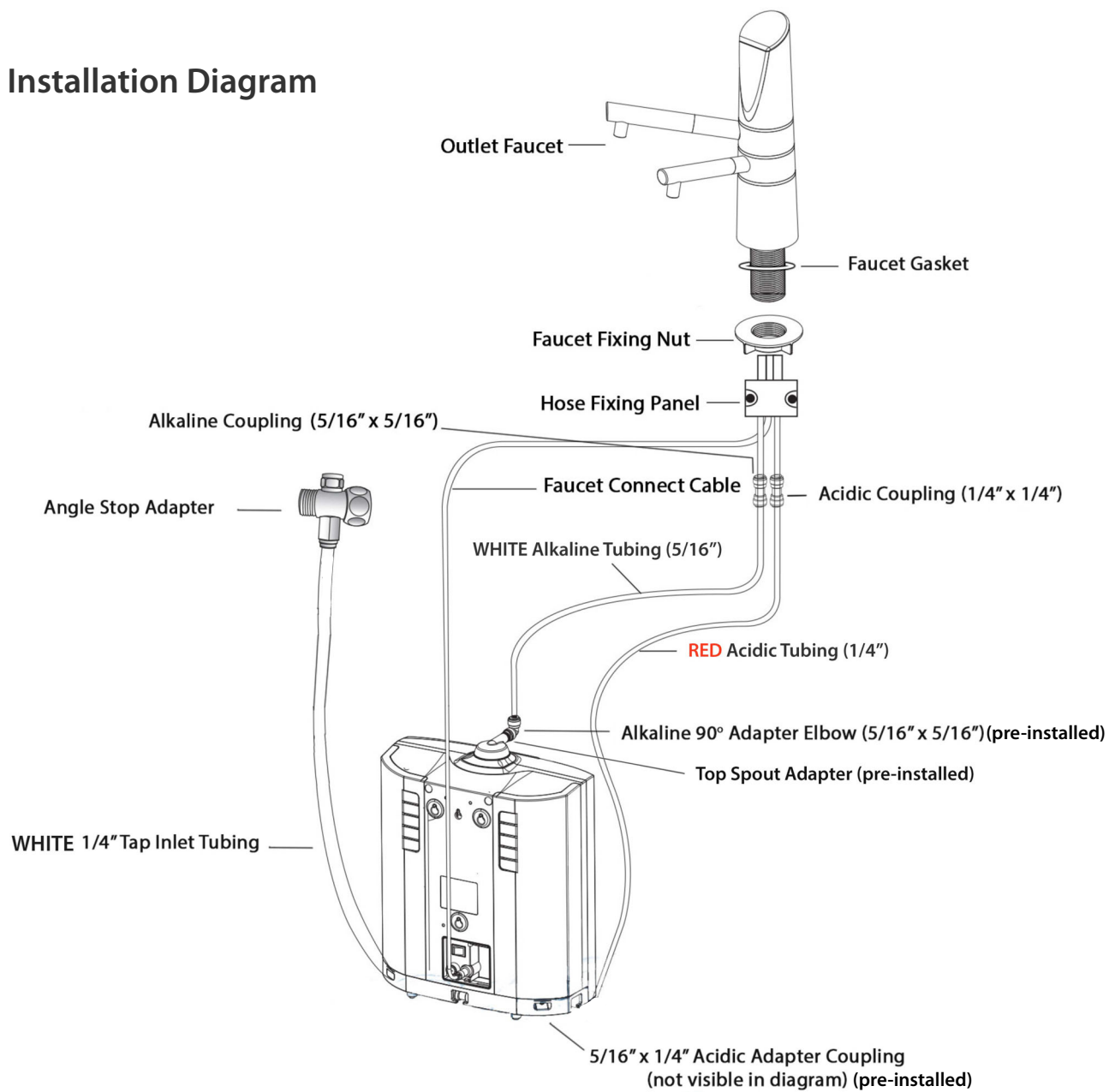

**Note:** We recommend using a licensed professional for the installation of the Delphi H<sub>2</sub>

## Do you have all of the included accessories?

Before installation, please check to ensure you have all the accessories pictured below.

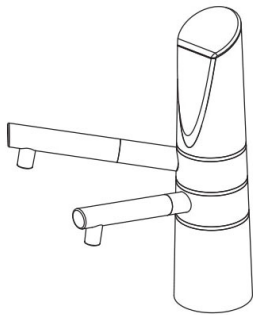

Delphi Faucet



Tubing X 3  
Acidic Water - 1/4" RED Tubing  
Water Inlet - 1/4" WHITE Tubing  
Alkaline Water - 5/16" WHITE Tubing



Top Spout Adapter  
(installed)

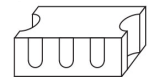

Hose Fixing Panel  
(Two Pieces)



### Fittings (pre-installed)

- 5/16" x 1/4" Coupling (pre-installed on the base)
- 5/16" x 5/16" 90° Elbow (pre-installed on the base)
- 1/4" Coupling Fitting (pre-installed on faucet)
- 5/16" Coupling Fitting (pre-installed on faucet)

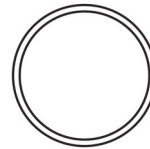

Gasket

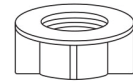

Fixing Nut



Cord Band



In-Line Sediment Filter  
(arrow indicates direction of water flow).



Safety Clips  
1/4" x 3  
5/16" x 3



Mounting Screws



If you have installation questions,  
please call AlkaViva Customer Service.

**(775) 324-2400**



Angle Stop Adapter  
with Fitting

(will look like one of the  
styles above, depending on  
your country)



pH Test Reagent

Extra Fuse (not pictured)

**We highly recommend you save the original packaging for your Delphi H<sub>2</sub> for future transportation.**



## Installing your Delphi H<sub>2</sub>



**CAUTION**

### Remove all plugs PRIOR to installation:

(1) Rubber Plug at Alkaline Spout, (1) Sleeve Plug at Acidic Elbow, (1) Quick Connect Plug at Tap Water Inlet (see [bit.ly/QC-fittings](http://bit.ly/QC-fittings) for instructions)

You will need a power outlet underneath your sink where the Delphi Base Unit will be plugged in. After your installation is complete, ALWAYS check for leaks.

### Step One: Installing the Delphi Faucet at your sink.

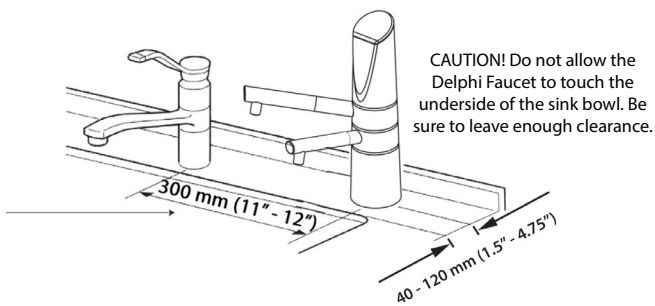

**CAUTION!** Do not allow the Delphi Faucet to touch the underside of the sink bowl. Be sure to leave enough clearance.

#### A. Preparing the Delphi Faucet Installation Hole (35 mm)

**IMPORTANT:** If you do not have an existing hole for installation, we recommend hiring a **licensed professional** for this step. Especially if you have granite, marble, or natural stone countertops.

**USE CAUTION!** Do not allow the threaded Delphi Faucet Base to touch the underside of the sink bowl. Leave enough clearance so it does not touch the sink bowl and the fixing nut can tighten all the way without obstruction.

1. Choose a location for the Delphi Faucet that will be easy to use and not interfere with other functions around your sink.
2. The location that you choose should be approximately 40mm - 120mm (1.5" - 4.75") from the sink and approximately 300mm (11" - 12") from the kitchen faucet.
3. Make sure the Delphi Faucet location allows both spouts to reach the sink.

#### B. Getting the Delphi Faucet Ready

1. Connect the 5/16" White Tubing to the 5/16" coupling fitting attached to the Delphi Faucet Tubing.
2. Connect the 1/4" Red Tubing to the 1/4" coupling fitting attached to the Delphi Faucet Tubing.
3. Pass the Red and White Tubing and Faucet Data Cable through the Faucet Gasket and hole in the countertop. Place the Delphi Faucet into the hole and secure with Fixing Nut.

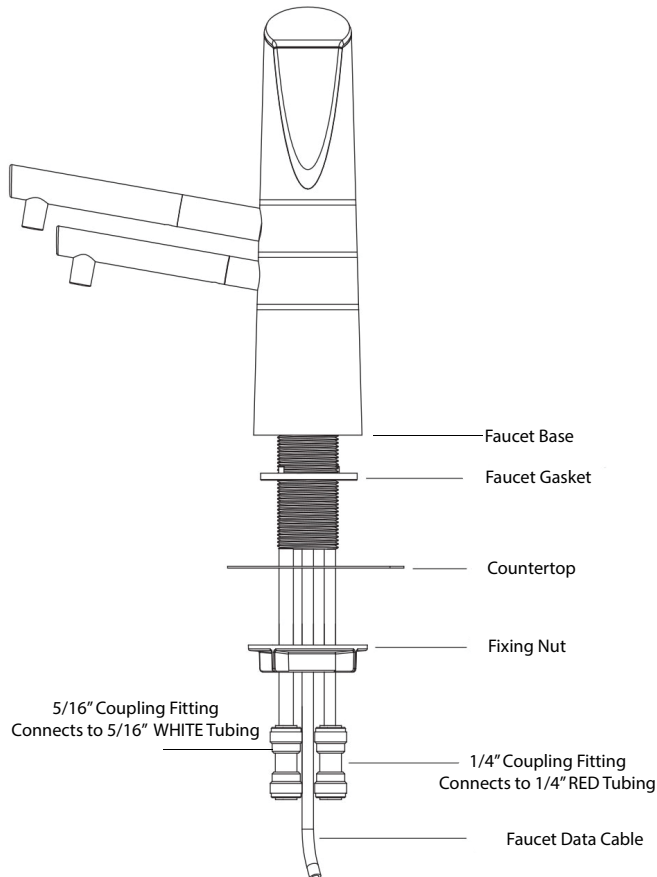

## Step Two: Installing the Angle Stop Adapter.

**CAUTION!** Make sure that all tubing is free of bends, kinks, or restrictions. If the tubing is too long, it can be trimmed to a shorter length as needed. After completion of tubing installation, make sure it is properly connected. Then, fix each hose connector with a safety clip (provided). After completion of tubing installation, DO NOT tilt the main unit.

### Install Angle Stop Adapter to Cold Water Supply Line

1. Locate the cold-water line. Shut off the cold-water supply at the Angle Stop.
2. Unscrew the flexible supply line from the Angle Stop. Attach the Angle Stop Adapter with the included Adapter Fitting (fits standard 1/2" and 3/8" plumbing).
3. Make sure the Angle Stop Adapter is in "closed" or OFF position, (blue knob parallel to the length of the body of the Angle Stop Adapter). Leave cold water line shut off. See Fig. 1.
4. Attach the White 1/4" Tap Water Inlet Hose to the Angle Stop Adapter (Fig. 1) by simply pushing firmly into the white port. Give a gentle tug to ensure proper connection. It should not come out.



## Step Three: Installing the Base Unit.

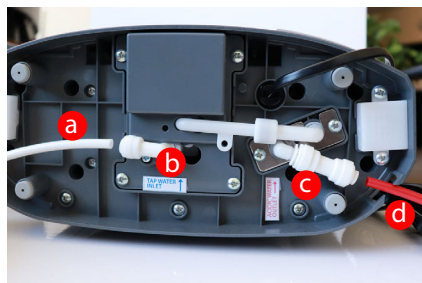

- a. 1/4" WHITE Tubing coming from Angle Stop Adapter
- b. Tap Water Inlet
- c. Acidic Water Outlet
- d. 1/4" RED Tubing coming from faucet

### Remove all plugs PRIOR to installation:

- (1) Rubber Plug at Alkaline Spout, (1) Sleeve Plug at Acidic Elbow, (1) Quick Connect Plug at Tap Water Inlet (see [bit.ly/QC-fittings](http://bit.ly/QC-fittings) for instructions)

1. Connect the 5/16" White Alkaline Tubing from the Delphi Faucet to the 5/16" Alkaline Elbow on the ionizer pre-installed at the top spout adapter (tubing can be trimmed if too long). To attach the White Tubing, simply push it firmly into the 5/16" Alkaline Elbow Fitting. Give it a gentle tug to ensure proper connection. It should not come out.
2. Attach the White 1/4" Tap Water Inlet Tubing from your Angle Stop Adapter to the Tap Water Inlet on the bottom of your ionizer. To attach the White Tubing, simply push it firmly into the TAP WATER INLET port. Give it a gentle tug to ensure proper connection. It should not come out.
3. Connect the 1/4" Red Acidic Tubing from the Delphi Faucet to the Acidic Adapter Coupling on the bottom of the ionizer. Always give it a gentle tug to ensure proper connection. It should not come out.
4. Plug in the Data Cable and install the Connector Cover Plate.
5. Connect the Power Cord – use an appropriately grounded outlet. Test the ionizer.

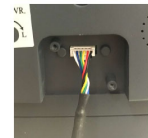

**CAUTION:** If you don't see the control panel light up, if water flows before you press the power button, if the water is flowing through only one spout, if you do not hear a voice announcing the mode of operation, or notice any other abnormal operations, stop, turn the water off, and restart the installation from the beginning.

## Operating Your Ionizer

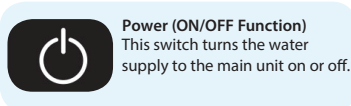

**Power (ON/OFF Function)**  
This switch turns the water supply to the main unit on or off.



**Acidic Ionized Water Button**  
Select the acidic ionized water that best suits your purpose.



**Alkaline Ionized Water Button**  
Select the alkaline ionized water that best suits your purpose.



**Filter Life Indicator**  
Displays 999 when a filter needs to be changed.



**Water Purification Button**  
Water will be filtered, but not ionized.



**Filter Indicator**  
Indicates which filter needs to be changed.

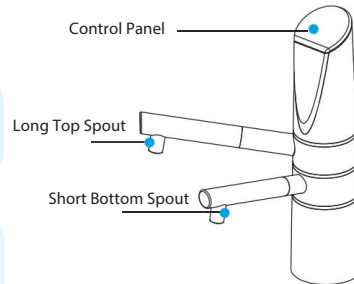

### Selecting Alkaline Ionized Hydrogen-Infused Water

When you select the ALK button, alkaline water will flow through the Long Top Spout of your Delphi Faucet and acidic water will flow through the Short Bottom Spout.



1. PRESS THE POWER button on the Delphi Faucet Control Panel. The Control Panel will light up.
2. Use the ALK button to select the level you wish to use. The level you have selected will light up.
3. You will hear voice confirmation, "Alkaline Level (1, 2, 3, 4, or 5) selected."
4. To change alkaline levels, simply press the ALK button to cycle through the alkaline levels. ALK 1 is the lowest setting and ALK 5 is the strongest.

### Selecting Acidic Water

When you select the ACID button, acidic water will flow through the Longer Top Spout of your Delphi Faucet and alkaline water will flow through the Short Bottom Spout.



1. PRESS THE POWER button on the Delphi Faucet Control Panel. The Control Panel will light up.
2. Use the ACID button to select the level you wish to use. The level you have selected will light up.
3. You will hear voice confirmation, "Acidic Level (1 or 2) selected".
4. To change acidic levels, simply press the ACID button to cycle through the acidic levels. ACID 1 is the lowest setting and ACID 2 is the strongest.
5. To prevent drinking acidic water, your H<sub>2</sub> Series Ionizer will automatically start back at your last drinking water setting the next time you start your ionizer.

**Note: Acidic water is not intended to be drinking water. Acidic water has many great uses. See Page 12.**

### Selecting Purified Water

Purified water is only filtered, not ionized. When selected, it will flow through both spouts of your Delphi Faucet.

1. PRESS THE POWER button on the Control Panel of the Delphi Faucet. The Control Panel will light up.
2. Use the PU button to select filtered water. The letters 'PU' will light upon the Delphi Faucet Control Panel.
3. You will hear voice confirmation, "Filtered water selected."



## Operating Your Ionizer (Cont'd)

### Manually Adjusting Power

While Auto Adjust automatically provides very fine real-time adjustments to the electrical pulse, you can also manually adjust the power to best suit your unique water quality and desired performance requirements.

By manually adjusting power settings for each Alkaline and Acidic Level, you can make bigger and more impactful changes in performance.

To manually adjust the power setting for each Alkaline and Acidic Level, select the Alkaline or Acidic Level you'd like to adjust - just as you would for changing levels under normal operation.

In this example, we will use Alkaline Level 5 with a desired power setting of 2.

Instructions:

1. Start by pressing the Power button on the Delphi Faucet Control Panel. The current setting will appear on the display.
2. Cycle through the Alkaline Settings by pressing the ALK button until you reach Alkaline 5 and **hold the ALK button until the display changes** and looks like Fig. 1.

The first digit (5 in this example) means "Alkaline Level 5" and second digit (2) means electric power setting 2. There are four electric power values available for each level of ionization.

Power Level 1 is the lowest and Power Level 4 the highest. If you want to raise or lower the Power Value, press the ALK button. The second digit will change to reflect the power setting.



Fig. 1

**\*Note: you must stop and hold the ALK button on the setting you would like to adjust, if you go past it just keep cycling through until you can stop and hold on the level you would like to adjust.**

3. Press the PU button to save the setting. The next time you use the ionizer it will remember the saved adjusted power setting.

You must set each ALK and ACID Power Level individually. For other levels, please repeat the steps above.

### To adjust the volume:

Using a small Phillips screwdriver, rotate the volume control screw clockwise to lower and counterclockwise to increase the volume



## Using Ionized Water



### Caution! Don't Develop a 'Drinking' Problem!

If you've never used hydrogen-infused ionized water, do not use an Alkaline Setting higher than 1 to begin with. Let your body adjust slowly and naturally for 2-3 days. After this initial adjustment period, gradually increase the alkalinity of the water by increasing the setting you use.

Do not take medications with ionized water. Take medications only with purified, filtered water.

Consult with a physician before drinking ionized water if you are currently under medical treatment, have a chronic disease, or have achlorhydria.

Consult a physician before using acidic water externally if you have sensitive skin or allergies.

Do not drink acidic water.

Only use potable drinking water in your ionizer. Poor water quality may have negative effects on your health and your ionizer! Most municipal water sources will be fine in your ionizer. Well water and water from smaller systems should be checked and may require pre-filtering.

Do not drink the following types of water:

- Acidic water.
- Water tested with the pH reagent, or pH reagent by itself.

Additional Cautions

- Do not use the water in an aquarium.
- Ionized water loses its effectiveness if stored for more than a day or two.

#### Suggested Alkaline Water Levels

5 – Cooking vegetables

4 – Making coffee / tea

3 – Cooking rice, grains, beans and pasta

2 – Drinking

1 – Drinking – start drinking at level 1 for 2-3 days. After this initial adjustment period, gradually increase the alkalinity of the water by increasing the setting you use.

**Helpful Hint:** Ionized hydrogen-infused water is always best fresh out of the ionizer and ideal if consumed on a day-to-day basis. Carry it with you in glass, ceramic or high quality BPA-free plastic bottles. Always keep your stored water cool and away from direct sunlight to preserve optimal water quality.

#### Purified Water Setting

Use this setting when taking medication.

#### Suggested Acidic Water Levels

1 – Washing face, hair, and mouth rinse

2 – Cleaning counters, cutting boards, etc.

## Other Uses for Hydrogen-Infused Alkaline Water

### Cooking rice

Try cooking rice after soaking the rice in the alkaline water for 30 - 60 minutes in advance. When cooking rice with the alkaline water, the rice will be glossy, tasty, and it will store better for a longer period of time.



### Coffee, black tea and herbal tea

Help remove the bitter taste of coffee and the puckery taste of black tea as well as enriching the faint taste and fragrance unique to black tea.

### Heavy drinking and hangover

If you drink a 12-16 oz glass before going to bed or on an empty stomach in the morning you will minimize the effect of a hangover.



### Various dishes

When cooking bamboo shoots, tree shoots, taro and seaweed with the alkaline water, the bitter taste and the sour taste will be gone while the natural taste will be enriched. When using it as the water for steaming fish, the fishy smell will be eliminated and it will make the fish taste better.

### Liquors and cocktails

When used as the water for mixing, liquor will taste softer and milder. When making a cocktail, use ice made from alkaline water.

### Plants

If seeds are soaked in the alkaline water before being planted, the germination rate will be enhanced. In case of stem cutting or grafting, they will take better.



### Vegetables and fruits

Wash vegetables or fruits in alkaline water and they can be kept fresh for a longer period of time.

### Vegetables with unpleasant odors

When cooked after being soaked in the alkaline water for about 20-30 minutes, odor will be reduced, making vegetables softer and tastier.



## Uses for Acidic Water

### Skin Care

Acidic water can be a beauty solution for your skin. It acts as an astringent and helps make the skin soft and elastic. (Skin is mildly acidic.)

### Hair Care

Use acidic water as a hair rinse after shampooing to neutralize the alkalinity of the shampoo, and help retain the hair's natural gloss.

### Shaving

Use acidic water after shaving; it can replace skin toner or after shave.

### Floral arrangement

Use acidic water for cut flowers. It will keep the flowers fresh for a longer period of time.

### Boiling eggs

When the acidic ionized water is used for boiling eggs, the shell is less likely to crack while cooking and the eggs will peel easily.

### Water for parboiling noodles

When the acidic ionized water is used for parboiling noodles, it will make them chewy and tastier.

### Washing or processing deep colored fruits and vegetables

Washing peaches, grapes, strawberries, red cabbages, beans and asparagus etc. with acidic water will retain their natural colors and they will stay bright and vibrant.

### When preparing fried dishes

Use acidic ionized water to prepare batter for fried dishes to make the foods crispy and tastier.

### General cleaning

When the acidic ionized water is used for cleaning floors, dirt and grime can be easily removed and it dries quickly.

### Cleaning glass

When glass, mirrors and glasses are washed with acidic ionized water, dirt and grime is easily removed and glass is shiny without streaks.

### Encrusted pots and pans

Soak pots and pans in the acidic ionized water overnight to remove encrusted or burnt food.

### Cleaning the cutting board or counters

Use acidic ionized water to naturally clean and sanitize your cutting board and counters.

### Cleaning dishes and silverware

Use acidic water for cleaning dishes and silverware. It will not leave spots.



## Replacing the H<sub>2</sub> Series Smart Filter

**IMPORTANT NOTE:** The Smart Filter will run for approximately 200 gallons beyond the end of the filter life. After that, the ionization will be disabled unless new Smart Filters are installed. Make sure you order your replacement filters in advance!

You can access the Filter Life Indicator by pressing the Purified Button on the Faucet when the unit is not running any water. Both filters need to be changed when the Filter Counter reaches 999. The Filter Life Indicator will also show on the Display when the Power button on the Faucet is pushed to Power off.

Considering that filter life span can differ based on water quality in individual areas, we recommend replacing the filter before the end of the life span is reached if the water smells or the water flow rate decreases.

Possible situations where filter life can be shortened:

- If there is sediment or impurities in the water
- If you have very low water pressure
- If you have untreated water, such as a private well

### Open Both Filter Covers (Fig. 1)

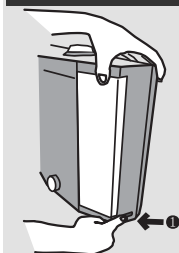

Fig. 1

Press the white button to unlock the cover. It is in the middle of the bottom of the cover.

### Remove the Cover (Fig. 2)

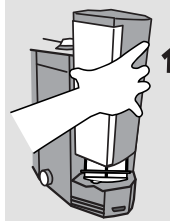

Fig. 2

With the cover unlocked, lift the cover straight up.

### Remove the Old Filters

Unplug the wire harness at the top of the filter. Twist the expired filter counterclockwise and lift out.



Remove the protective sticker on the base of the new filters.

### Install New Filters (Fig. 3)



Fig. 3

Be sure each filter is in its proper place: Pre-Filter / Fluoride Filter goes in the right side, Main Filter goes in the left side. Insert the opening at the base of the filter onto the raised filter base. Twist clockwise until locked into place.

Check for leaks. Leaks occur when filter is not seated properly. In this case, take filter out and reinstall.

### Install New Filters (Fig. 4)

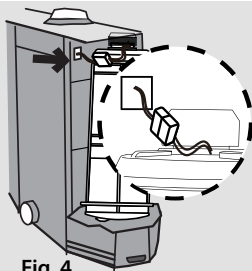

Fig. 4

Reconnect the wire harness to the new filters.

This will reset the Filter Life Indicator to 0.

### Install New Filters (Fig. 5)



Fig. 5

Close the covers by lining up the vertical edges and slide down until you feel / hear the cover lock.

Always flush your new filters using the Purified Setting for 1 - 2 minutes or until the water runs clear.



## Adding Optional Calcium Inserts

Use calcium inserts if you have soft water.

1. Ensure the water flow is off.
2. The inserts go into a port on the top of your filter. To access the filter, follow the 'Replacing the H<sub>2</sub> Series Smart Filter' instructions.
3. Once you have the filter removed, unscrew the cap on the top of the filter body. If you have previously used an insert, dispose of the old insert. (Fig 1)
4. The new insert will have a soft silicone protective cap. Remove the cap.
5. Place the new insert into the port on the top of the filter, with the open end up. **DO NOT EMPTY THE CONTENTS INTO THE PORT.** (Fig. 2)
6. Replace the cap on the port of the filter. Tighten firmly to prevent leaking.
7. Replace the filter following the 'Replacing the H<sub>2</sub> Series Smart Filter' instructions.



Fig. 1



Fig. 2

## Installing the Optional In-line Sediment Filter

Consider using the In-line Sediment Filter if the aerator on your faucet needs regular cleaning, meaning there is sediment in your water. An In-line Sediment Filter is included with all ionizer models. Install the In-line Sediment Filter on 1/4" White Tubing somewhere between your source water and the tap water inlet (arrow located on filter indicates direction of water). Cut tubing according to your installation needs. See photos below.



1. In-line Sediment Filter attaches to 1/4" White Tubing as pictured.

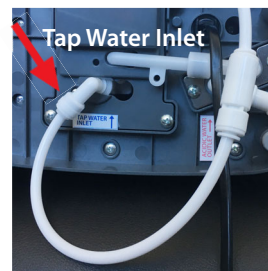

2. Install shortest part of tubing at the Tap Water Inlet - make sure the arrow on the Sediment Filter points towards the TAP WATER INLET.

## Operating the Quick Connect Fitting

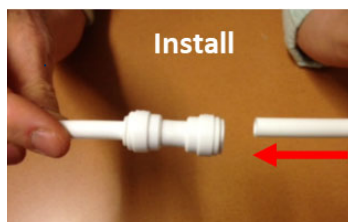

Install

**Install:** Insert tubing into Quick Connect Fitting and PUSH IN firmly until it can't go further. Give a gentle tug to ensure proper connection.

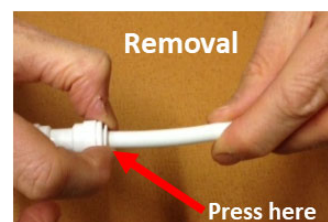

Removal

Press here

## Troubleshooting

Condition	Possible Cause(s)	Resolution
The Delphi H <sub>2</sub> is not operating as expected after following the installation steps	The steps at setup were not performed properly	Disconnect and restart installation steps from the beginning.
	The tubing is installed improperly	
	The Data Cable was unplugged from the Base Unit	
The Control Panel does not come on	The power plug is not properly inserted, or it is inserted into a faulty outlet	Properly insert power plug into a correctly functioning power outlet.
	The fuse is blown	Replace the fuse. A spare fuse is included in your reagent kit (3A / 110 V fuse).
	The fuse is not inserted properly	
The Control Panel / Display Indicators do not come on after starting water flow through the ionizer	Faulty Flow Sensor Faulty Circuit Board	Immediately unplug the unit and contact AlkaViva to arrange service
pH test shows little or no change in color	Most likely, your reagent is out of date and has expired. This is usually caused by age, exposure to light, heat, or air	Replace reagent
Power supply is suddenly cut off while operating the unit	Electrical problems including safety switches and fuses	Check your power outlet or replace fuse
	High level of TDS or salts in the water, extended time of operation, sudden change in electrical current. In these cases, your machine will shut down automatically to protect the electrodes and circuitry	The AutoAdjust feature has built-in protection from extended use or high TDS. Wait 30 - 60 minutes and try to operate your ionizer again
Low or slow flow of alkaline water from the ionizer	Clogged filter. Premature clogging may be caused by a sudden drop in water quality and an influx of sediment or other contaminants, which stress the filter	Replace your filter  Clean pre-filter
	Low pressure in your household plumbing	Ensure water supply valves are fully open. Increase water flow from supply
	The input tubing is bent, kinked, or otherwise restricted	Straighten the bent, kinked, or restricted tubing
No acid water flow from the acidic output port	Acidic output hose is bent, kinked or otherwise obstructed	Straighten the bent, kinked, kinked or otherwise obstructed hose. Increase water flow from supply

Delphi H<sub>2</sub> Series Manual  
Alkaline Water Ionizer  
And Hydrogen Generator

Abnormal Condition	Possible Cause(s)	Resolution
Water leaking from the filter cartridge housing	Filter not installed correctly in the filter housing	Remove your filter and reinstall it properly following the filter replacement instructions. Increase water flow from supply
Water appears milkish - white snow like particles in the bottom of your glass	You have high levels of hardness (calcium, primarily) in your water. The white is extracted CaCO <sub>3</sub> (calcium carbonate)	This is calcium! It is harmless to ingest, and actually good for you. Remember, the ionizer separates and condenses the alkaline minerals and this is what you are seeing. You can lower the setting (1-2) and reduce this effect. Typically, this only occurs in hard water areas. See Page 3
At first, no smell, but then smell from the alkaline water about one hour later	Expired filter	Replace filter(s)
	Your water bottle or receptacle is dirty and needs cleaning. Contamination mixes with alkaline water when filling your bottle	Clean your water bottle or receptacle
Strange smell from alkaline water	Expired filter from ordinary use, or clogging from change in water quality	Replace filter(s)
	Sudden change in water quality with elevated level of some disinfectants and naturally occurring elements in the water (not Chlorine). These elevated levels are observed in some areas during the summer months. These levels fall within safe drinking water standards, yet will cause a reaction with ionized water, causing a unique smell	Select a lower pH level. If the smell is still present, you may consider replacing your filter



# ALKAVIVA

Hydrogen Enhanced Living

Delphi H<sub>2</sub> Series Manual | v2.04.20

